

**SERIE KOSMOS**



DIGITAL PANEL INSTRUMENT  
FOR LVDT SENSOR



# **MODEL ALPHA-L**

MODBUS-RTU PROTOCOL COMPATIBLE

INSTRUCTIONS MANUAL

Code: 30727079  
Edition: 30 November 2000

**ALPHA-L**  
English

## INTRODUCTION TO THE KOSMOS SERIES

---

**This manual does not constitute a formal agreement. All information given in this manual is subject to change without notice.**

---

The KOSMOS SERIES brings a new philosophy in digital panel instrumentation which is expressed by multipurpose, modular-concept devices providing a rich array of basic functions and advanced capabilities.

With a fully MODULAR DESIGN, it is possible to implement a wide variety of applications by only adding the adequate options.

Intelligence within allows the meter to recognize the options installed and ask for the necessary parameters to properly function within desired margins. The parameters related to non-installed options are removed from the program routines.

The instruments CALIBRATION is made at the factory eliminating the need for adjustment potentiometers. Any circuit or option liable to be adjusted incorporates a memory where calibration parameters are stored, making it possible the optional cards be totally interchangeable without need of any subsequent adjust.

Custom CONFIGURATION for specific applications can be made quickly and easily through five front panel keys, following structured choice menus aided by display prompts at each programming step.

Other features of the KOSMOS family include :

- CONNECTIONS via plug-in terminal blocks without screws and CLEMP-WAGO clips cable retention system.
- DIMENSIONS  
Models ALPHA & BETA 96x48x120 mm DIN 43700  
Models MICRA & JR/JR20 96x48x60 mm DIN 43700
- CASE MATERIAL UL-94 V0-rated polycarbonate.
- PANEL INSTALLATION without screws by means of single part fastening clips.

---

To guarantee the meter's technical specifications, it is recommended to recalibrate the meter at periodical intervals according to the ISO9001 standards for the particular application operating criteria. Calibration should be performed at the factory or in a qualified laboratory.

# **MODEL ALPHA-L**

**INDEX**

1 . MODEL ALPHA-L OVERVIEW .....	4/ 5
1.1. - KEYBOARD AND DISPLAY DESCRIPTION.....	6/ 7
2 . GETTING STARTED.....	8
2.1 - POWER AND CONNECTORS.....	9/ 10
2.2 - PROGRAMMING INSTRUCTIONS.....	11/ 12
2.3 - INPUT CONFIGURATION .....	13/ 16
2.4 – RECOMENDATIONS FOR CALIBRATION .....	16
2.4.1 – MASTER-SLAVE .....	16
2.5 - DISPLAY CONFIGURATION .....	17/ 27
3 . KEYBOARD AND REMOTE CONTROLS	
3.1 - KEYBOARD FUNCTIONS .....	28/ 29
3.2 - REMOTE FUNCTIONS .....	30
3.3 - TABLE OF PROGRAMMABLE FUNCTIONS.....	31/ 32
3.4 - REMOTE FUNCTIONS PROGRAMMING .....	33/ 34
3.5 - LOCK OUT PROGRAMMING. ACCESS LEVELS .....	35
4 . OUTPUT OPTIONS.....	36/ 37
4 .1 - ADDED OUTPUT FUNCTIONS .....	38
5 . TECHNICAL SPECIFICATIONS.....	39
5.1 - DIMENSIONS AND MOUNTING .....	40
6 . WARRANTY .....	41
7 . DECLARATION OF CONFORMITY .....	43

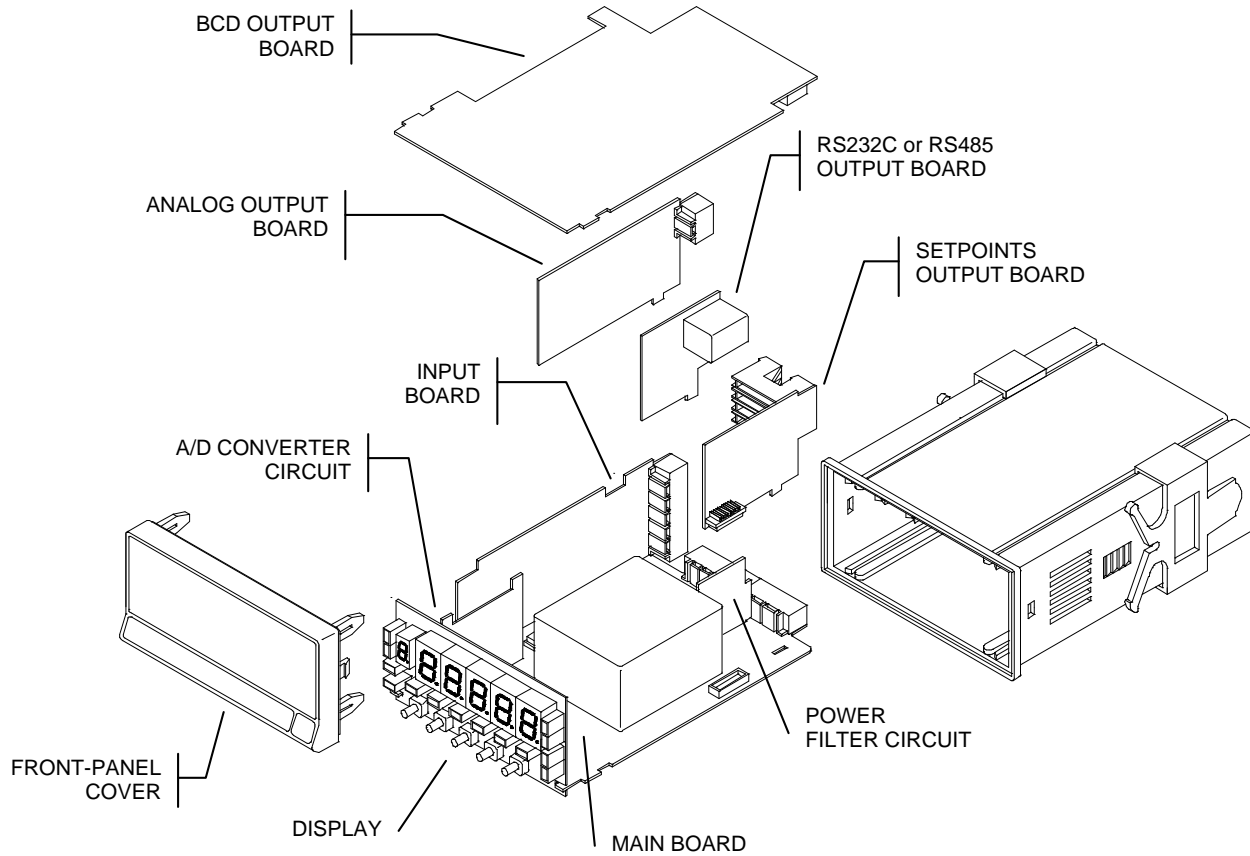

# 1. MODEL ALPHA-L

**The model ALPHA-L from the KOSMOS Serie, incorporates new technical and functional characteristics including  $\pm 32000$  count display, signal linearization of up to 12 points and user programmable remote logic functions, direct access to the setpoints programming.**

ALPHA-L is designed to be connected to a wide range of LVDT 3 or 4 wires sensors ( without integrated electronics) that allows the measurement of lengths, distances and displacements in any unit system, metric or english units.

The programming using an easy menu, allows to introduce the sensor specific characteristics to adapt the instrument to the sensor. The instrument has the system Teach-Cal that allows an easy and accurated calibration in a 11 steps linearisation that increases the total linearisation of the system. The signal can be filtered in three different levels to stabilize the signal in different kind of process. The basic instrument is an assembly composed of the MAIN BOARD, the DISPLAY and the power FILTERING circuit, plus the A/D converter card and the INPUT card which are installed in their corresponding plug-in connectors (see figure in page 4).

Standard features of the basic instrument include the reading of the input variable, max and min readings detection, remote hold operation, tare function and reset and a full complement of programmable logic functions.

In addition, a variety of plug-in output cards can be installed at any time to meet further system requirements:

## COMMUNICATION

RS2	Serial RS232C
RS4	Serial RS485
BCD	BCD 24V/TTL

## CONTROL

ANA	Analogue 4-20mA, 0-10V
2RE	2 SPDT relays 8A
4RE	4 SPST relays 0.2A
4OP	4 NPN outputs
4OPP	4 PNP outputs

All the outputs are opto-isolated with respect to the input signal.



This instrument conforms to the following directives: 89/336/CEE and 73/23/CEE  
Caution: Read complete instructions to ensure safety protections.

# FRONT-PANEL FUNCTIONS IN RUN MODE

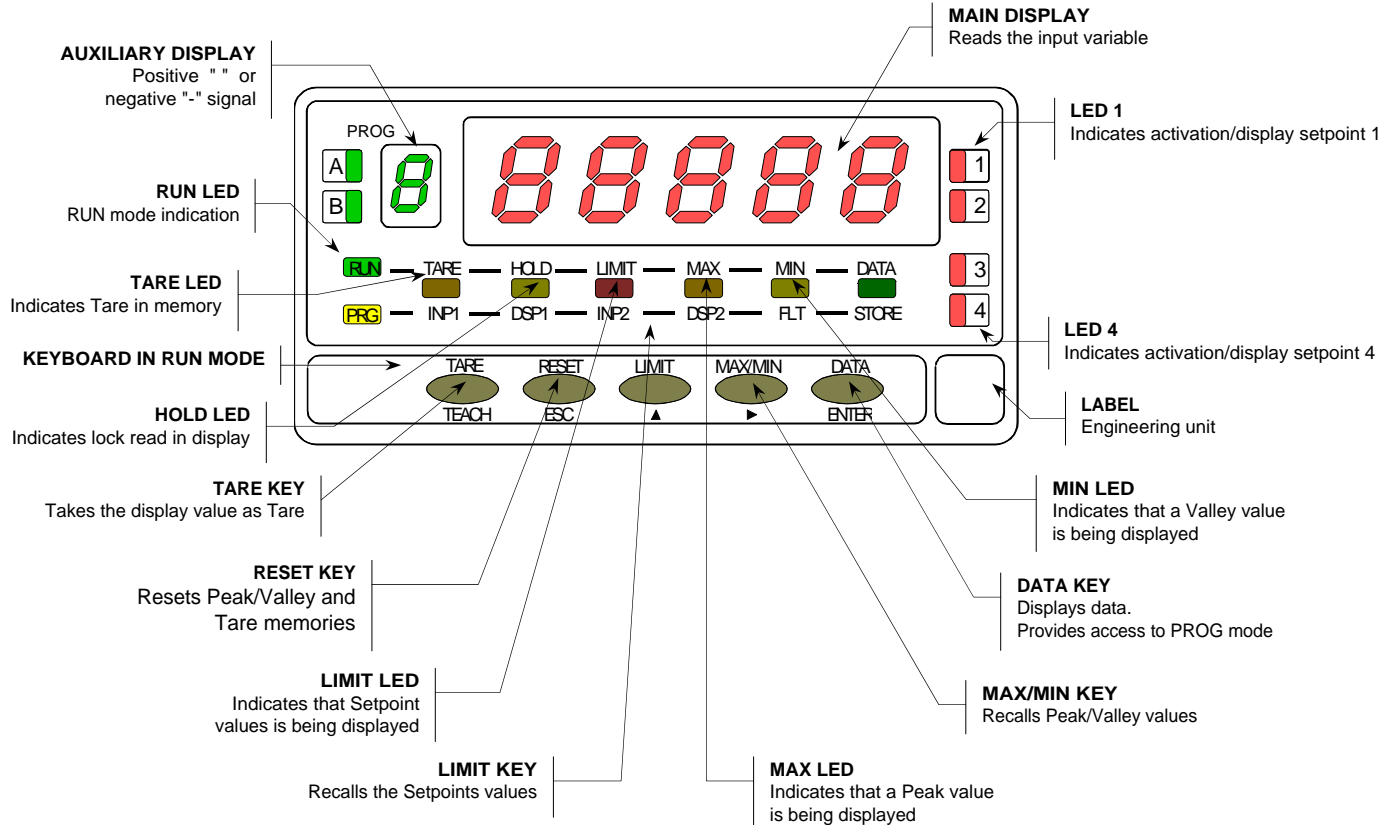

# FRONT-PANEL FUNCTIONS IN PROG MODE

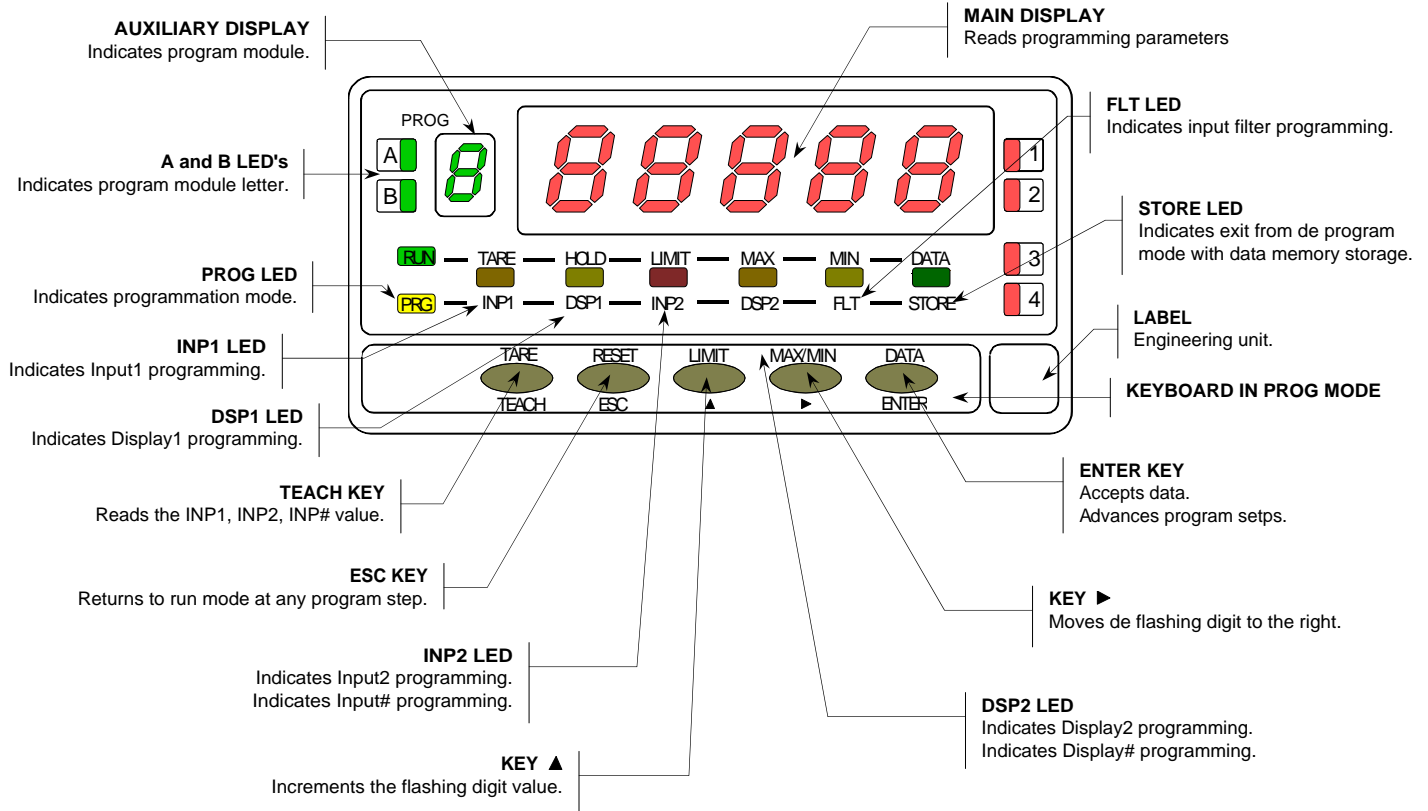

## 2. GETTING STARTED

### PACKAGE CONTENTS

- ❑ Instructions manual in English including Declaration of Conformity.
- ❑ D.P.M. model Alpha-L.
- ❑ Accessories for panel mounting (sealing gasket and fastening clips).
- ❑ Accessories for wiring connections (removable plug-in connectors and fingertip).
- ❑ Wiring label stuck to the Alpha-L case. (Ref. 30700132)
- ❑ Four sets of engineering units labels. (C° ref. 30700070, L ref. 30700071, Hm ref. 30700073, Cos ref. 30700072)
- ✓ **Check the package contents.**

### CONFIGURATION

#### Power supply (page 9 and 10)

- ❑ Instruments supplied for 115/230V AC power are factory set for 230V AC. (USA market 115V AC).
- ❑ Instruments supplied for 24/48V AC power are factory set for 24V AC.
- ❑ Instruments supplied for 10-30V DC can be powered from any voltage between 10 and 30V DC without need of making changes.
- ✓ **Check the wiring label before power connection.**

#### Programming instructions (page 11 and 12)

- ❑ The software is divided into several independently accessible modules for configuration of the input, the display, the setpoints, the analog output, the communication output and the logic inputs.
- ✓ **Read carefully this section.**

#### Input type (page 13, 14, 15 and 16)

- ❑ The instrument provides three excitation voltages to supply the transducer; 5V or 10V and 24V, are set up at fabrication for 10V.
- ✓ **Check the transducer sensitivity, for more detailed information, please consult the transducer specifications.**

#### Programming Lock-out (page 35)

- ❑ The instrument is set at the factory with the switches on the OFF position (program routines are totally accessible).
- ✓ **Check the 2-position Dip-switch  located on the main board beside the display circuit.**



## 2.1 - Power supply

Should any hardware modification be performed, remove the electronics from the case as shown in figure 9.1.

**115/230 V AC:** The instruments with 115/230 V AC power, are shipped from the factory for 230 V AC (USA market 115 V AC), see figure 9.2. To change supply voltage to 115 V AC, set jumpers as indicated in figure 9.3 (see table 1). The wiring label should be modified to match new setups.

**24/ 48 V AC:** The instruments with 24/48 V AC power supply, are shipped from the factory for 24 V AC, see figure 9.3 To change supply voltage to 48 V AC, set jumpers as indicated in figure 9.2 (see table 1). The wiring label should be modified to match new setups.

**10-30V DC:** The instruments for 10-30V DC power supply are prepared to withstand any voltage between 10 and 30V without need of wiring changes.

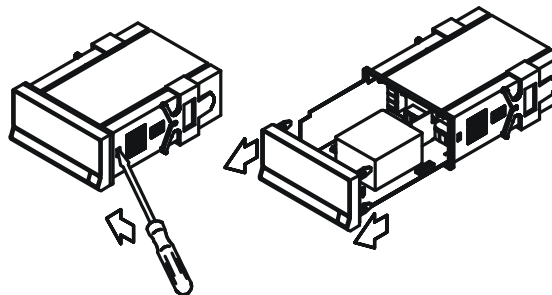

Fig. 9.1. Remove case

Table 1. Jumper settings

Pin	1	2	3	4	5
230V AC	-	■		■	
115V AC	■		■		-
48V AC	-	■		■	
24V AC	■		■		-

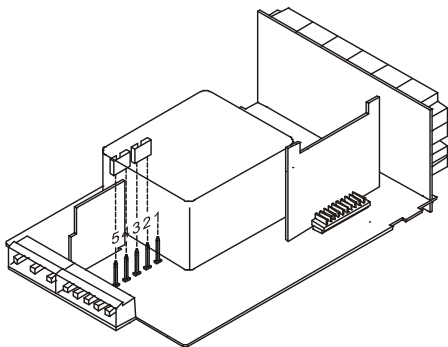

Fig. 9.2. Supply voltage 230 V or 48 V AC

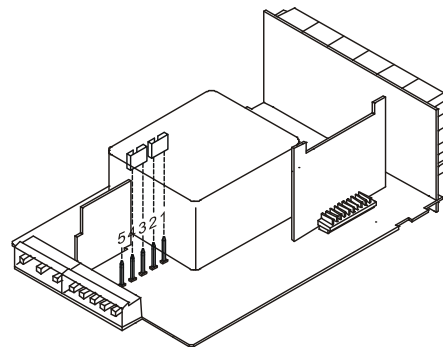
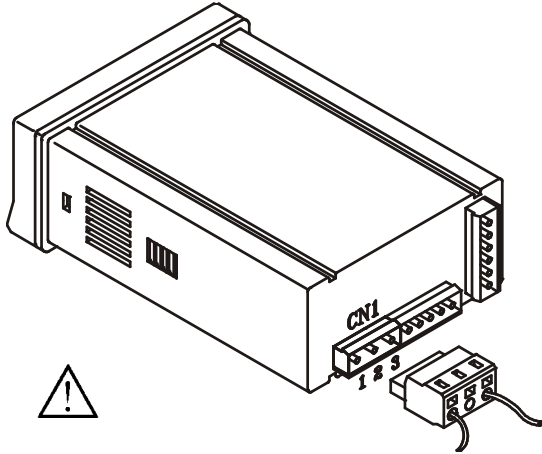

Fig. 9.3. Supply voltage 115 V or 24 V AC

## POWER CONNECTION



### AC VERSIONS

PIN 1 - AC HI

PIN 2 - GND (GROUND)

PIN 3 - AC LO (NEUTRAL)

### DC VERSIONS

PIN 1 - DC POSITIVE

PIN 2 - N/C (no connection)

PIN 3 - DC NEGATIVE

## INSTALLATION

To meet the requirements of the directive EN61010-1, where the unit is permanently connected to the mains supply it is obligatory to install a circuit breaking device easy reachable to the operator and clearly marked as the disconnect device.

### WARNING

In order to guarantee electromagnetic compatibility, the following guidelines for cable wiring must be followed:

- Power supply wires must be routed separated from signal wires. Never run power and signal wires in the same conduit.
- Use shielded cable for signal wiring and connect the shield to ground of the indicator (pin2 CN1).
- The cable section must be  $\geq 0.25 \text{ mm}^2$

**If not installed and used according to these instructions, protection against hazards may be impaired.**

## CONNECTORS

To perform wiring connections, remove the terminal block from the meter's connector, strip the wire leaving from 7 to 10mm exposed and insert it into the proper terminal while pushing the fingertip down to open the clip inside the connector as indicated in the figure.

Proceed in the same manner with all pins and plug the terminal block into the corresponding meter's connector.

Each terminal can admit cables of section comprised between  $0.08 \text{ mm}^2$  and  $2.5 \text{ mm}^2$  (AWG 26 ÷ 14).

The blocks provide removable adaptors into each terminal to allow proper fastening for cable sections of  $< 0.5 \text{ mm}^2$ .

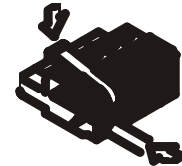

## 2.2 – Programming instructions

### Access to the programming mode

When power is applied to the instrument, the display briefly illuminates all segments and LED's then shows the software version and finally enters in the normal reading mode. Press **ENTER** to enter in the programming mode. The display shows the indication "-Pro-" (fig. 11.1).

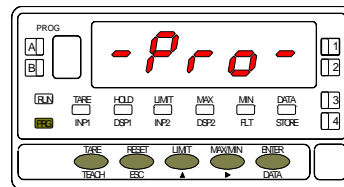

Fig. 11.1. PROG mode first step (-Pro- stage)

### Exit from the programming mode without saving data

From any step of the program routines, a push of **ESC** returns the meter to the run mode. The instrument retains any change made before exiting in this mode but does not save new data in the memory. To effectively discard changes, switch power off and on.

### Save changes in the configuration

From the last step of each program menu, a push of **ENTER** returns the meter to the run mode keeping all changes in the parameter list. The LED STORE illuminates while the new configuration is saved in the memory

### Guidelines on programming instructions

The programming software is divided into 6 modules. Each module is organized in several independently accessible menus and each menu contains a list of parameters necessary to configure a specific function of the meter.

From the -Pro- stage, press repeatedly **▶** to cycle around the existing modules : module 10 = Input configuration, module 20 = display configuration, module 30 (if option installed) = setpoints, module 40 (if option installed) = analog output, module 50 (if option installed) = serial outputs and module 60 = logic functions. Press **ENTER** to acced selected module.

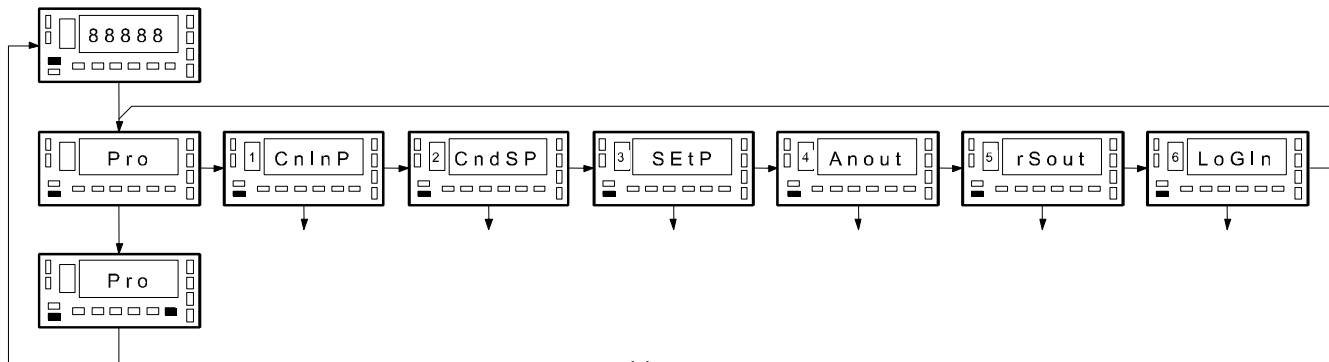



The programming instructions are composed by a general description and a series of step-by-step instructions to be followed sequentially. Each menu step is represented by an illustration of the display and keyboard module with indicators (display and LED's), reference [page number . figure number] and a text describing the action of each key at that step.

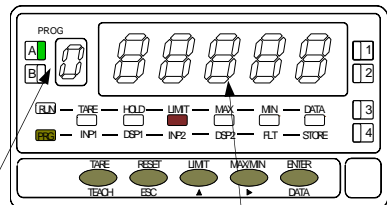



## [page n°/figure n°] Mnemo







Program module and menu step indicators

In the step-by-step instructions, you are given the action of the three buttons mainly used to program data. The normal procedure at each step is to push on  a number of times to make changes and push on  to validate changes and advance to the next programming step. At the end of a complete menu sequence the meter returns to the run mode saving changes in memory.

In general the following actions can be made during the program mode.

-  validate changes and advance to next step
-  discard changes and go to the run mode
-  select among a list of available options / shift to next digit to the right
-  increment digit value

With respect to the figures in the step-by-step instructions, the display indications may have the following meanings :

1. The display shows one of the available options with filled-out segments. That means that the display shows the choice made previously. The use of  allows to select from available options.
2. A series of black "8" also represents the display indication of a previous choice, with the difference that it cannot be changed in the current step. If it is already the desired parameter, you may exit from the menu by a push of  without making changes or, if wanted to modify it, a push of  advances the meter to the next step where changes are allowed.
3. A series of white "8" represents any numerical value that is programmed by using keys  (increment digit value) and  (advance to the next digit).

## 2.3 – Input configuration

### [13.1] Input configuration

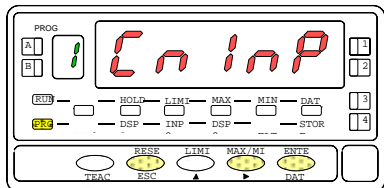

From the run mode, press **ENTER** to get access to the programming mode (the –Pro indication appears on display). Press the **▶** key to make the display show the indication given on figure 13.1 that corresponds to the entry stage of the input programming module.

- ▶** To skip over this stage and go to the display programming module.
- ENTER** To access the input type selection.
- ESC** To exit from the programming mode without saving changes.

### [13.2] Working mode

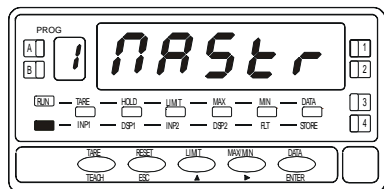

The first step of the configuration menu will show the way the instrument will work, as MASt (Master) or SLAUE (Slave). By pressing the **▶** key select if stand alone instrument (Master) or with other instruments (Slave)

- ENTER** To access to the frequency menu selection.
- ESC** To exit from the programming mode without saving the changes.

### [13.3] Frequency selection

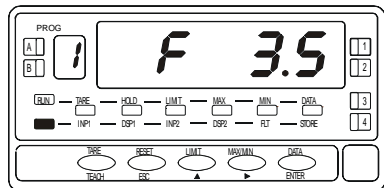



The display shows the frequenz of the transductor excitation signal, by pressing **▶** key, you can change it to 5 and 3,5 kHz.

- ENTER** To access to the excitation voltage selection.
- ESC** To exit from the programming mode without saving the changes.

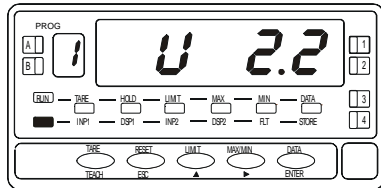
### [14.1] Excitation voltage





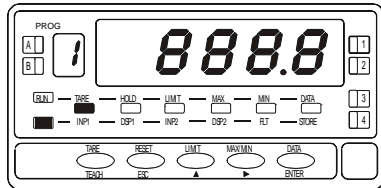

Press the  key to select the excitation voltage 2,2 or 1V

-  To save the entry into the memory and return to the next program step.
-  To exit from the programming mode without saving changes.

### [14.2] Sensor sensibility





It is shown the sensor sensibility value programmed in mV / V / mm and by pressing the key  you can change the value of the blinking digit and by pressing the key  it goes from left to right. The decimal point is fixed and the sensibility range is from 000.1 to 999.9 mV / V / mm

-  To save the entry into the memory and return to the next program step.
-  To exit from the programming mode without saving changes.

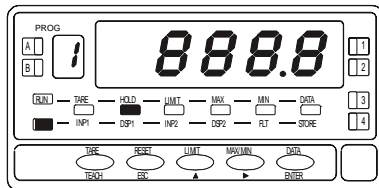
### [14.3] Select total sensor's measuring range



It is shown the measurement range value from 000.1mm to 999.9mm. Following the previous step method, introduce the sensor value indicated on its technical notes.

-  To save the entry into the memory and return to the run mode.
-  To exit from the programming mode without saving changes.

## Input signal connection

Refer to the connections recommendation section page 10.  
Instrument back view.

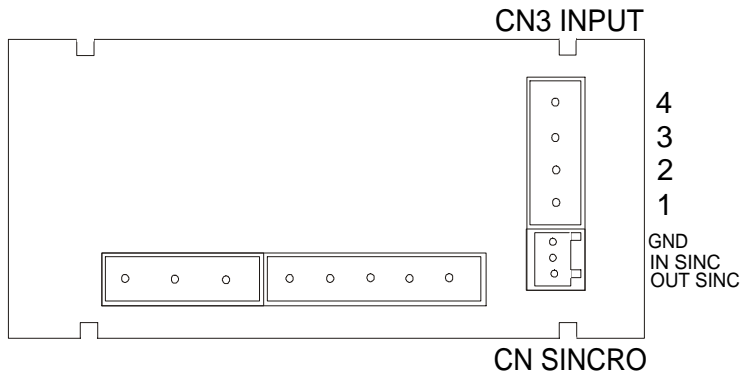

## LVDT SENSOR

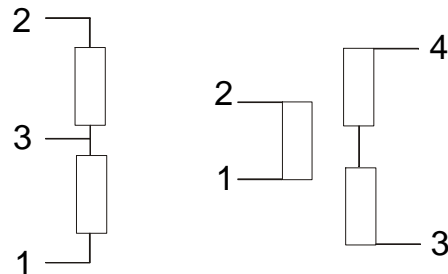

## FOR DISPLACEMENT SENSOR

### 3 WIRES SENSOR CONNECTION HALF-BRIDGE

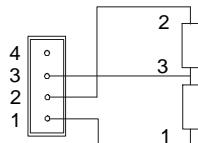

### 4 WIRES SENSOR CONNECTIONS DIFERENTIAL

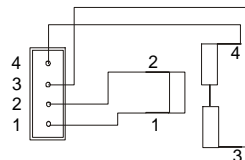

### 2.4.1 SEVERAL ALPHA-L INDICATORS CONNECTION

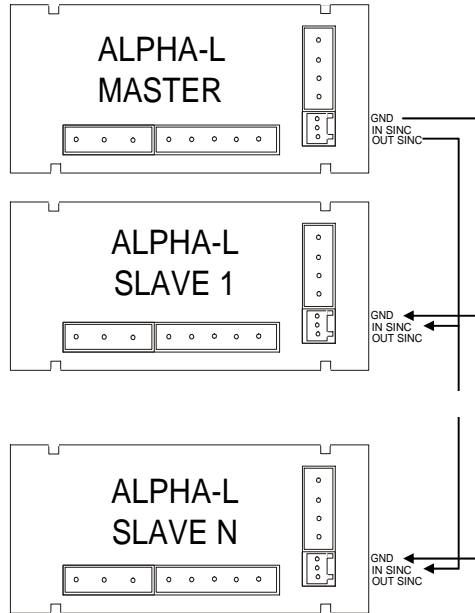

Fig 16.1

### 2.4 CALIBRATION NOTES

After configuring the input (sensor data) it is recommended to program following the method **SCAL** the values of **INP1**= 0.000, **DISP1**=-3000, **INP2**= 10000, **DSP2** = 3000 validate this data and put the instrument in RUN mode.

Situate the sensor so that the core is centered in its middle displacement range and move the core until the reading shows 0 or nearest in the display. Fix it and by using calibrated material displace the core to the end and program **SCAL** with the **TEACH** method for the input 1, indicating in **DSP1** the reference value with polarity if we are working with central zero, repeat the operation with the opposite end and indicate in **DSP2** the new reference value used.

#### 2.4.1 MASTER-SLAVE

When mounting two sensors one near the other, interference between the excitation signal may be, that could distort the measurement. To prevent this effect the connection may be as shown in fig. 16.1 that synchronizes the slave frequency with the MASTER.



## 2.4 - Display configuration

After selection of the input range, it may be necessary to scale the instrument for the particular application. For many common applications, single slope scaling (2 points) should be sufficient to have good readings over the entire process range. Other applications, in which non-linear devices are used may require linearizing the signal. This is accomplished by scaling the meter with more than two points (see fig. 17.1)

Type of function	Nº of scaling points
Linear function	2 points
Non-linear function	Max 12 points

### 1. Scaling the display.

The procedure of scaling the display consists of programming a minimum of two points composed each by an input (INP#) and a display (DSP#) coordinates.

When scaling the meter with two points (linear function), they should be located near the process limits for the best possible accuracy.

For multi-point scaling, it is recommended to use the most possible number of points and to reduce the segment length. **The input signal values of the scaling points must be all increasing or all decreasing. Avoid programming two different displays for two equal inputs.** The display values can be entered in any order and even be repeated for two or more input values.

Fig. 17.1: Linearizing function with 6 segments (7 points). Up to 11 segments are available.

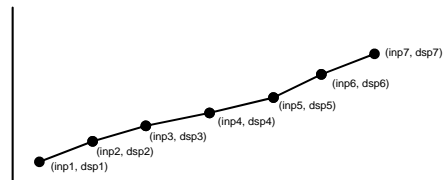

### 2. Action modes

The figure below represents two modes of operation obtained by programming increasing or decreasing display values for increasing input values.

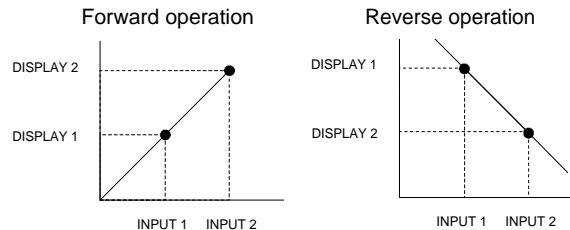

Forward operation :

- When input signal increases, the display increases.
- When input signal decreases, the display decreases.

Reverse operation :

- When input signal increases, the display decreases.
- When input signal decreases, the display increases.

### 3. Scaling the indicator.

After deciding the values for INPUT and DISPLAY and the decimal point position, we are ready to enter in the display configuration module (2 CndSP) to effectively scale the meter. The scaling procedure is completed with digital filters and display rounding.

#### [18.1] Display configuration

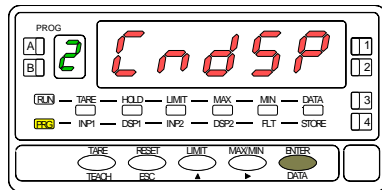

From the run mode, press **ENTER** to get access to the programming mode (the display shows -Pro-). Press two times the **▶** key to go to the entry stage of the display configuration module, represented in fig. 18.1. This module provides five menus : scaling, balanced filter, damping filter, round and tare (lockout). Press **ENTER** to access to the first menu (SCAL) and press repeatedly the **▶** key if you want to shift around the different menus (See next pages for instructions on each menu).

**ENTER** To get access to the menu select.

**ESC** To exit from the programming routines and brings the instrument to the run mode.

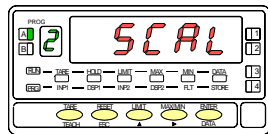

MENU 2A  
SCALING

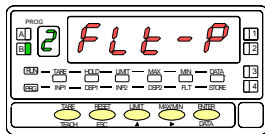

MENU 2B  
BALANCED FILTER

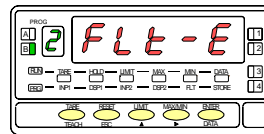

MENU 2B  
DAMPING FILTER

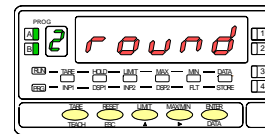

MENU 2AB  
ROUND FILTER

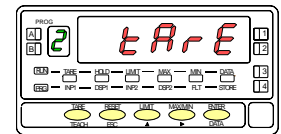

MENU 2  
TARE

## MENU 2A - SCALING

This menu allows programming the necessary parameters to determine the display range (INP1 - DSP1 - Decimal Point - INP2 - DSP2 - INP3 - DSP3 ...). As a default, these values are expected to be introduced by keyboard. To use the actual signal input values as INP# parameters, it is sufficient to push on the **TEACH** key while in the INPUT programming phases.

### [19.1] Scaling configuration

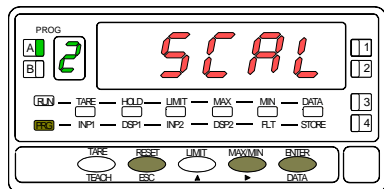

The figure 19.1 shows the indication (SCAL) corresponding to entry stage into the scaling menu. Press **ENTER** to access this menu.

- ENTER** To access the scaling configuration.
- ▶** To skip over this stage and go to the next programming menu.
- ESC** To exit from the programming mode without saving changes.

### [19.2] Input 1 value

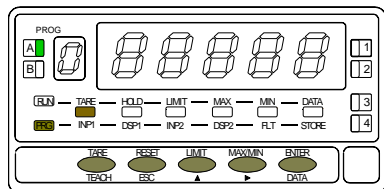

The previously programmed INP1 value appears on the display, LED INP1 activated, with the auxiliary digit (sign) in flash. There are two methods to program input values:  
**Key-in method:** Use **▲** to switch between "0" (positive) and "-" (negative). Press **▶** to advance to the next digit to the right which goes in flash. Press repeatedly **▲** to increment the active digit until it takes desired value. Proceed in the same manner with all the digits until desired value is completed on the display with sign. Press **ENTER** to accept this value as INP1 and go next step.

**Teach method:** Apply signal to the meter input. Press **TEACH** to view the actual signal value present at the input connector (LED INP1 flashes). Press **ENTER** to accept this value as INP1 and go next step.

- ESC** To exit from the programming mode without saving changes.

### [19.3] Display 1 value

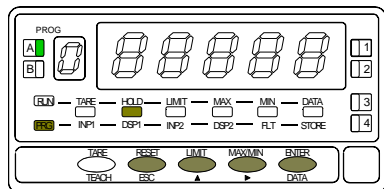

The previously programmed DSP1 value appears on the display, LED DSP1 activated, with the auxiliary digit (sign) in flash. By means of the **▲** and **▶** procedure, program desired DSP1 value and press **ENTER**. The limits of the span are -32000 and 32000 points. If the programmed value exceeds from these limits, the meter indicates Error, then displays 32000 to allow reprogramming the DSP1 value within limits.

- ENTER** To save the entry into the memory and go to the next programming menu.
- ESC** To exit from the programming mode without saving changes.

## [20.1] Decimal point

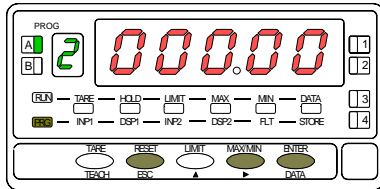

The decimal point goes in flash.

Press repeatedly the  key to move it to the right until desired position. If no decimal point is required, it must be placed to the right side of the display. The decimal point remains in the selected position in all programming phases and the run mode.





 To save the entry into the memory and go to the next programming menu

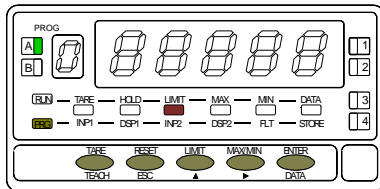

 To exit from the programming mode without saving changes.

## [20.2] Input 2 value



The previously programmed INP2 value appears on the display, LED INP2 activated, with the auxiliary digit (sign) in flash. There are two methods:



**Key-in method:** Use  to switch between "0" (positive) and "-" (negative). Press  to advance to the next digit to the right which goes in flash. Press repeatedly  to increment the active digit until it takes desired value. Proceed in the same manner with all the digits until desired value is completed on the display with sign. Press  to accept this value as INP2 and go next step.

**Teach method:** Apply signal to the meter input. Press  to view the actual signal value present at the input connector (LED INP2 flashes). Press  to accept this value as INP2 and go next step.

 To exit from the programming mode without saving changes.

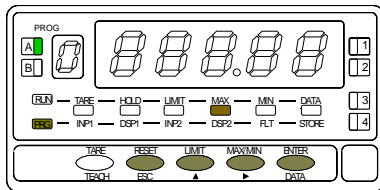
## [20.3] Display 2 value



The previously programmed DSP2 value appears on the display, LED DSP2 activated, with the auxiliary digit (sign) in flash. By means of the  and  procedure, program desired DSP2 value and press . The limits of the span are -32000 and 32000 points. If the programmed value exceeds from these limits, the meter indicates Error, then displays 32000 to allow reprogramming the DSP2 value within limits.

a) To validate data and access to multi-slope scaling, press  for 3 seconds; or

b) To save the entry into the memory and return to run mode, press .

 To exit from the programming mode without saving changes.

**VERY IMPORTANT:** Scaling the meter with a tare value different from zero may cause false readings when exiting to the run mode. Before trying to program the scale, check the TARE LED and, if activated proceed to clear the tare

### [21.1] Point 3

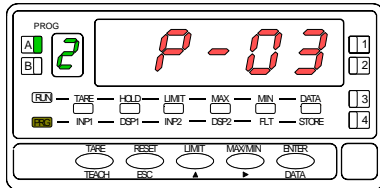

1 second flag indication for scaling point 3.

Multi-slope scaling sequence begins at this step.

### [21.2] Input 3 value

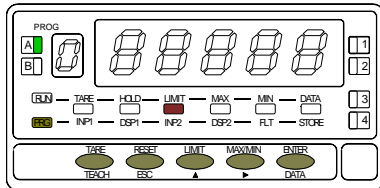

The previously programmed INP3 value appears on the display, LED INP2 activated, with the auxiliary digit (sign) in flash. There are two methods to program input values:  
**Key-in method:** Use **▲** to switch between "0" (positive) and "-" (negative). Press **▶** to advance to the next digit to the right. Press repeatedly **▲** to increment the active digit until it takes desired value. Proceed in the same manner with all the digits until desired value is completed on the display with sign. Press **ENTER** to accept this value as INP3 and go next step.

**Teach method:** Apply signal to the meter input. Press **TEACH** to view the actual signal value present at the input connector, LED INP2 flashes. Press **ENTER** to accept this value as INP3 and go next step.

### [21.3] Display 3 value

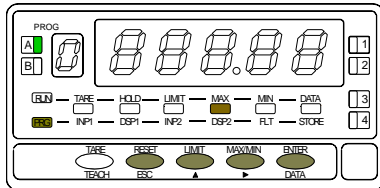

The previously programmed DSP3 value appears on the display, LED DSP2 activated, with the auxiliary digit (sign) in flash. By means of the **▲** and **▶** procedure, program desired DSP3 value and press **ENTER**. The limits of the span are -32000 and 32000 points. If the programmed value exceeds from these limits, the meter indicates Error, then displays 32000 to allow reprogramming the DSP3 value within limits.

- To validate data and advance to the next point, press **ENTER**; or
- To save the programmed data in the memory and return to the run mode, the meter is scaled with two segments, press and hold down **ENTER** for 3 seconds.

**ESC** To exit from the programming mode without saving changes.

## [22.2] Point 4

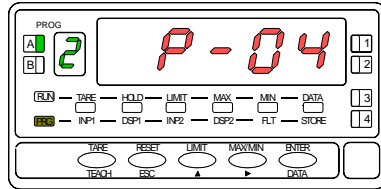

1 second flag indication for scaling point 4.

NOTE: The instructions given for programming point 4 are applicable to the programming of points 5 to 11.

## [22.3] Input 4 value

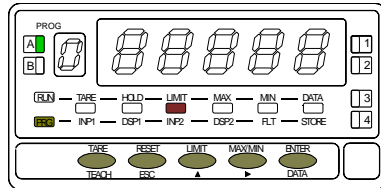

The previously programmed INP4 value appears on the display, LED INP2 activated, with the auxiliary digit (sign) in flash. There are two methods to program input values:

**Key-in method:** Use to switch between "0" (positive) and "-" (negative). Press to advance to the next digit to the right which goes in flash. Press repeatedly to increment the active digit until it takes desired value. Proceed in the same manner with all the digits until desired value is completed on the display with sign. Press to accept this value as INP4 and go next step.

**Teach method:** Apply signal to the meter input. Press to view the actual signal value present at the input connector, LED INP2 flashes. Press to accept this value as INP4 and go next step.

To exit from the programming mode without saving changes.

## [22.4] Display 4 value

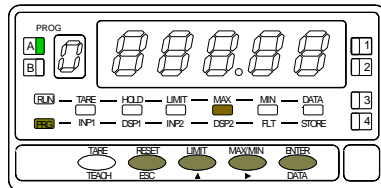

The previously programmed DSP4 value appears on the display, LED DSP2 activated, with the auxiliary digit (sign) in flash. By means of the and procedure, program desired DSP4 value and press . The limits of the span are -32000 and 32000 points. If the programmed value exceeds from these limits, the meter indicates Error, then displays 32000 to allow reprogramming the DSP4 value within limits.

a) To validate data and advance to the next point ; press ; or  
b) To save the programmed data in the memory and return to the run mode, the meter is scaled by three segments, press and hold down for 3 seconds.

Return to previous point.

### [23.1] Point 12

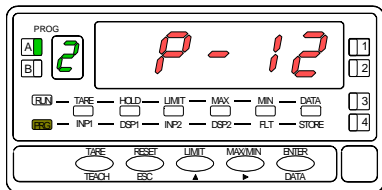

1 second flag indication for scaling point 12.

### [23.2] Input 12 value

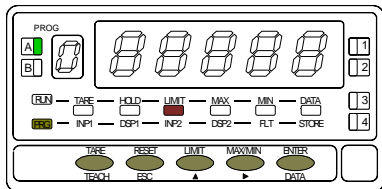

The previously programmed INP12 value appears on the display, LED INP2 activated, with the auxiliary digit (sign) in flash. There are two methods to program input values:

**Key-in method:** Use to switch between "0" (positive) and "-" (negative). Press to advance to the next digit to the right which goes in flash. Press repeatedly to increment the active digit until it takes desired value. Proceed in the same manner with all the digits until desired value is completed on the display with sign. Press to accept this value as INP12 and go next step.

**Teach method:** Apply signal to the meter input. Press to view the actual signal value present at the input connector, LED INP2 flashes. Press to accept this value as INP12 and go next step.

### [23.3] Display 12 value

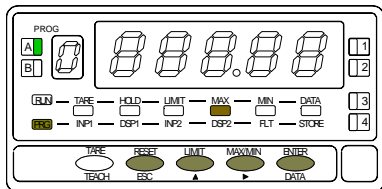

The previously programmed DSP12 value appears on the display, LED DSP2 activated, with the auxiliary digit (sign) in flash. By means of the and procedure, program desired DSP12 value and press . The limits of the span are -32000 and 32000 points. If the programmed value exceeds from these limits, the meter indicates Error, then displays 32000 to allow reprogramming the DSP12 value within limits.

To save the entry into the memory, the meter is scaled with eleven segments, and return to run mode.

Return to previous point.

## MENU 2B - BALANCED FILTER

The balanced filter acts as a delay on the display response to signal variations produced at the input. The effect of incrementing this filter level results in a softer response of the display to the input variations.

The filtering level is programmable from 0 to 9. Level 0 disables the filter.

### [24.1] Balanced filter

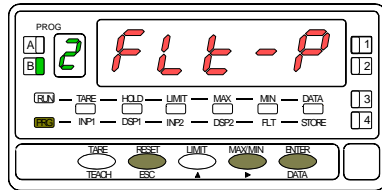

The figure 24.1 shows the indication (FLt-P) corresponding to entry stage of the balanced filter menu. Press the **ENTER** key to access this menu.

- ENTER** To get access to program filter level.
- ▶** To skip over this menu and go to next one.
- ESC** To exit from the programming mode without saving changes.

### [24.2] Filter value

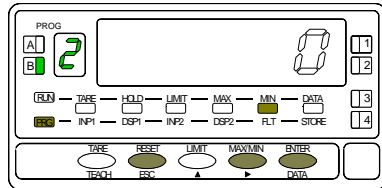

The figure 24.2 shows the initially selected level for the filter-P (any number between 0 and 9) with the FLT LED activated.

Press repeatedly the **▶** key to change the digit until desired value appears on the display.

- ENTER** To save the entry in the memory and go to the next programming menu.
- ESC** To exit from the programming mode without saving changes.



## MENU 2B - DAMPING FILTER

The damping filter cuts off input values exceeding from the limits of a moving band. This band becomes more selective as the filter level is increased.

The filtering level is programmable from 0 to 9. Level 0 disables the filter.

### [25.1] Damping filter

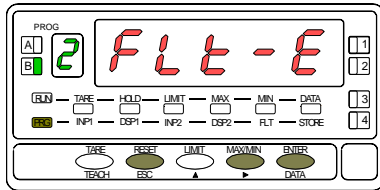

The figure 25.1 shows the indication (FLt-E) corresponding to entry stage of the damping filter menu. Press the **ENTER** key to access this menu.

- ENTER** To get access to program the filter level.
- ▶** To skip over this menu and go to next one.
- ESC** To exit from the programming mode without saving changes.

### [25.2] Filter value

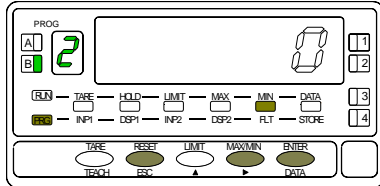

The figure 25.2 shows the initially selected level for the E-filter (any number between 0 and 9) with the FLT LED activated.

Press repeatedly the **▶** key to change the digit until desired value appears on the display.

- ENTER** To save the entry in the memory and go to the next programming menu.
- ESC** To exit from the programming mode without saving changes.

## MENU 2AB - ROUND FILTER

This menu allows selection among 4 levels of display rounding. When resolution is not critical, a rounding increment higher than 1, may help to stabilize the display.

### [26.1] Round filter

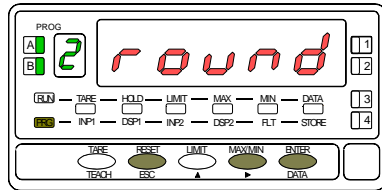

The figure 26.1 shows the indication corresponding to the round menu. Press **ENTER** to access the configuration.

- ENTER** To get access to the round level selection.
- ▶** To Skip over this menu and pass to the next one.
- ESC** To exit from the programming mode without saving changes.

### [26.2] Rounding increment

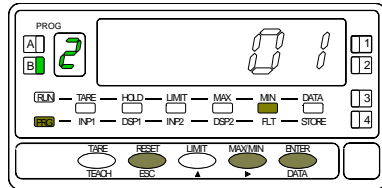

Programming of the rounding increment, LED FLT activated.  
The display shows the previously selected round level. To change this parameter, press repeatedly the **▶** key to rotate around the different options : [01 = no rounding, 02 = round to 2 counts, 05 = round to 5 counts, 10 = round to 10 counts].

- ENTER** To save the option present on display and return to the run mode.
- ESC** To exit from the programming mode without saving changes.

## MENU 2 - TARE

This menu allows enabling and disabling the tare function and its reset.

### [27.1] Tare menu

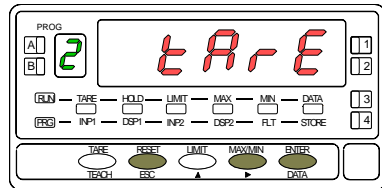

The figure 27.1 shows the indication corresponding to the tare menu. Press **ENTER** to access the configurations.

- ENTER** To get access to the tare menu.
- ▶** To Skip over this menu and pass to the next one.
- ESC** To exit from the programming mode without saving changes.

### [27.2] Tare Lock/Unlock

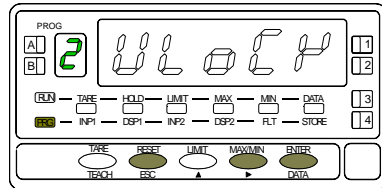

Lock/Unlock TARE function.

The initially programmed option appears on the display : [ **UloCK** = tare function enabled, **LoCK** = tare function disabled ].

- ▶** To switch between lock and unlock indications until desired option is displayed.
- ENTER** To save the option present on display and return to the run mode.
- ESC** To exit from the programming mode without saving changes.

## 3. KEYBOARD AND REMOTE CONTROLS

### 3.1 - Keyboard functions

The front-panel keyboard includes the following function keys: TARE, RESET, LIMIT and MAX/MIN. The functionality of each one, which is available in the "RUN" mode is described next.

**TARE.** A push of this key adds the current display value to the tare memory and brings the display to zero. The "TARE" LED indicates that a tare value different from zero is contained in the tare memory.

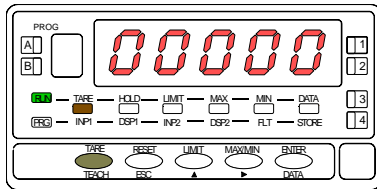

[28.1] Tare operation

To reset the tare memory press and hold down the "RESET" key, then press the "TARE" key. Release first "TARE" then "RESET". To take a tare or reset it back to zero, be sure these functions are enabled by software (see Fig. 22.2, TARE menu, UnLoCK option).

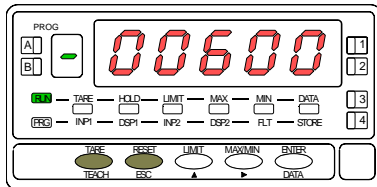

[28.2] Tare reset

**LIMIT.** During the RUN mode, this key is only operative in case that the instrument incorporates one of the following output options: 2 relays (ref. 2RE), 4 relays (ref. 4RE), 4 NPN transistors (ref. 4OP) or 4 PNP transistors (ref. 4OPP).

At one push of "LIMIT" key the display illuminates the "limit" LED and reads the first programmed setpoint value with the LED 1 activated. New strokes on the LIMIT key recall successively the rest of the setpoints with the corresponding LED (on the right) activated.

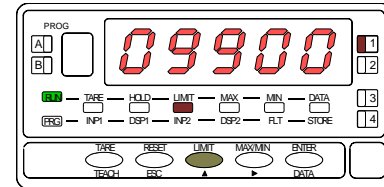

[28.3] Setpoint 1 value

The setpoint values are shown at each push of the "LIMIT" key independently of whether they are enabled or inhibited. 15 seconds after the last key operation or by a push of "LIMIT" from the visualization of the last setpoint, the auxiliary display blanks and the meter returns to the normal reading.

**MAX/MIN.** This key calls up the peak and valley values contained in memory. The first push recalls the maximum value reached for the variable since the last reset operation (peak) and activates the "MAX" LED.

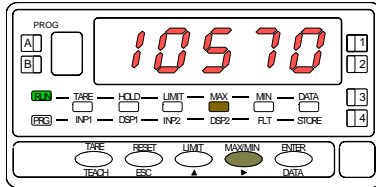

[29.1] Peak

To erase the peak and/or valley memories, press "MAX/MIN" one or two times to display the value to be reset. Press and hold down the "RESET" key and simultaneously press "MAX/MIN". Release "MAX/MIN" then "RESET".

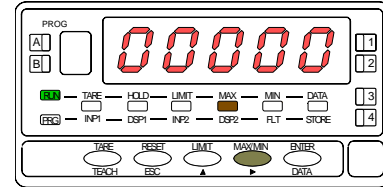

[29.3] Reset of the peak memory

The second push recalls the minimum value registered after the last reset (valley) and activates the "MIN" LED.

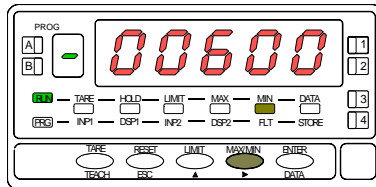

[29.2] Valley

**RESET.** The "RESET" key is used in conjunction with "TARE" and "MAX/MIN" to erase the memories of tare and peak/valley respectively.

When a tare or a tare reset operation is performed, the peak and valley are updated with the new display value.

A third push brings the meter to the normal reading. The peak and valley values are updated even when they are registered on the display.

## 3.2 - Remote functions

The rear connector CN2 provides 4 user programmable optocoupled inputs that can be operated from external contacts or logic levels supplied by an electronic system. Four different functions may be then added to the functions available from the front-panel keys. Each function is associated to one of the CN2 connector pins (PIN 1, PIN 2, PIN 4 and PIN 5) and is activated by applying a falling edge or a low level pulse to the corresponding pin with respect to common (PIN 3). Each pin can be assigned one of the 28 functions listed on the following pages.

- **Default configuration**

As shipped from the factory, the CN2 connector allows the TARE, MAX/MIN and RESET operations be made in the same way as from the front-panel keyboard and incorporates one more function: the display HOLD.

The HOLD state, which is acknowledged by the LED "HOLD", freezes the display, the BCD and the analog outputs but does not halt the meter's internal operation nor the alarm outputs. The HOLD state is maintained as long as pin2 is kept to a low level with respect to pin 3.

### CN2 : DEFAULT CONFIGURATION

PIN (INPUT)	Function	Number
PIN 1 (INP-1)	RESET	Function n° 7
PIN 2 (INP-2)	HOLD	Function n° 9
PIN 3	COMMON	
PIN 4 (INP-4)	TARE	Function n° 1
PIN 5 (INP-5)	PEAK/VALLEY	Function n° 6

The external electronics (see fig. 30.1) applied to the CN2 connector must be capable of withstanding 40V and 20mA present at all terminals with respect to COMMON. In order to guarantee the electromagnetic compatibility, please refer to the instructions given on page 10.

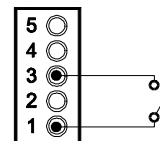
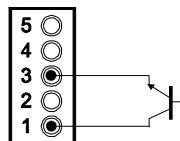
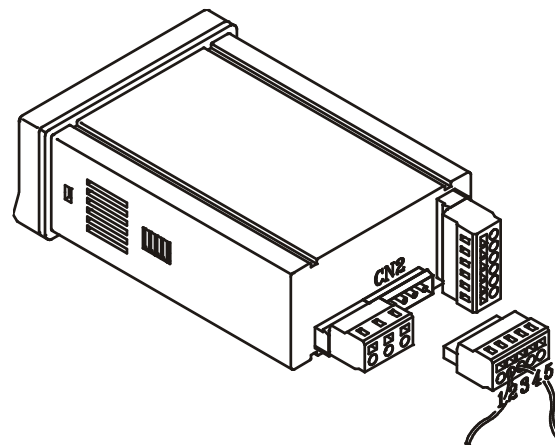

Fig. 30.1: Examples of one pin external connection for electronic (left) or mechanical devices (right).

### 3.3 - Table of programmable functions

- **N°:** Function number.
- **Function:** Function name.
- **Description:** Description and characteristics of the function.
- **Activation :**
  - **Falling edge :** The operation is performed on a falling edge applied to the pin with respect to COMMON.
  - **Low level :** The function remains activated while the corresponding pin is held at a low level with respect to COMMON.
- (\*) Default factory configuration. It can be restored by programming all pins to '0'.

#### 0 to 9 : DISPLAY / MEMORY FUNCTIONS

N°	Function	Description	Activation
0	None	Deactivated. The pin has no function	None
1	TARE (*)	Adds the current display value to the tare memory. The display goes to zero	Falling edge
2	RESET TARE	Adds the tare memory contents to the display value and clears the tare memory	Falling edge
3	PEAK	Recalls peak value. A new falling edge returns to normal reading	Falling edge
4	VALLEY	Recalls valley value. A new falling edge returns to normal reading	Falling edge
5	RESET PEAK/VALLEY	Clears the peak or valley memory (if the values are on display)	Falling edge
6	PEAK/VALLEY (*)	1 <sup>st</sup> push recalls peak, 2 <sup>nd</sup> push recalls valley, 3 <sup>rd</sup> push brings the meter to the indication of the variable being measured	Falling edge
7	RESET (*)	Combined with (1) clears the tare memory Combined with (6) clears the peak or valley memories	Falling edge combined with (1) or (6)
8	HOLD1	Holds the display while the outputs remain active	Low level
9	HOLD2 (*)	Holds the display, the BCD, RS and the analog outputs	Low level

#### 10 to 12 : FUNCTIONS ASSOCIATED WITH THE DISPLAY OF THE INPUT VARIABLE

N°	Function	Description	Activation
10	INPUT	Displays the actual input signal value in V or mA (flashing)	Low level
11	GROSS	Displays the measured value + the tare value = gross	Low level
12	TARE	Displays the amount of tare contained in the memory	Low level

### 13 to 16 : FUNCTIONS ASSOCIATED WITH THE ANALOG OUTPUT

N°	Function	Description	Activation
13	ANA GROSS	Makes the analog output follow the gross value (measured value + tare)	Low level
14	ZERO ANA	Puts the analog output to the zero state (0V for 0-10V, 4mA for 4-20mA)	Low level
15	ANA PEAK	Makes the analog output follow the peak value	Low level
16	ANA VALLEY	Makes the analog output follow the valley value	Low level

### 17 to 23 : FUNCTIONS FOR USE WITH A PRINTER VIA THE RS OUTPUTS

N°	Function	Description	Activation
17	PRINT NET	Prints the net value	Falling edge
18	PRINT GROSS	Prints the gross value	Falling edge
19	PRINT TARE	Prints the tare value	Falling edge
20	PRINT SET1	Prints the setpoint1 value and its output status	Falling edge
21	PRINT SET2	Prints the setpoint2 value and its output status	Falling edge
22	PRINT SET3	Prints the setpoint3 value and its output status	Falling edge
23	PRINT SET4	Prints the setpoint4 value and its output status	Falling edge

### 24 to 25 : FUNCTIONS ASSOCIATED WITH THE SETPOINTS AND RS OUTPUTS

N°	Function	Description	Activation
24	FALSE SETPOINTS	Exclusively for instruments WITHOUT relays/transistors control outputs card. Allows programming and operation of 4 setpoints	Low level
25	RESET SETPOINTS	Exclusively for instruments with 1 or more setpoints programmed as "latched setpoints" (That is, the setpoints that once energized remain on the ON status although the alarm condition disappears). Deactivates the setpoints output	Falling edge

### 26 to 28 : SPECIAL FUNCTIONS

N°	Function	Description	Activation
26	ROUND RS	The display value as sent via the RS output, includes no filtering or rounding	Low level
27	ROUND BCD	<b>Makes the BCD output follow the display value without rounding</b>	Low level
28	SEND ASCII	Transmits the four last digits of the display to a remote ASCII indicator. By holding the input to a low level, transmission takes place every second.	Falling edge / Low level



### 3.4 – Remote functions programming

After deciding the functions for each connector pin, we are ready to enter in the logic inputs configuration module (6 LoGIn) to effectively program the logic inputs.

#### [33.1] Logic inputs

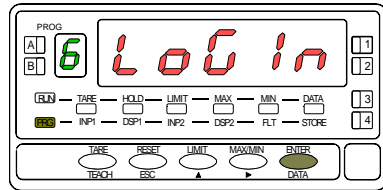

From the run mode, press **ENTER** to get access to the programming mode (the display shows -Pro-). Press six times the **▶** key to go to the entry stage of the logic inputs configuration module, represented in fig. 33.1. This module provides four menus for programming the input pins. Press **ENTER** to access to the first menu (InP1) and press repeatedly the **▶** key if you want to select to different pins.

**ENTER** To get access to select menu.

**ESC** To exit from the programming routines and bring the instrument to the run mode.

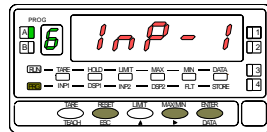

MENU 6A  
PIN 1 PROGRAMMING

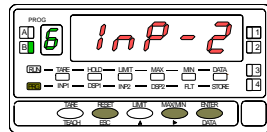

MENU 6B  
PIN 2 PROGRAMMING

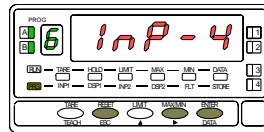

MENU 6AB  
PIN 4 PROGRAMMING

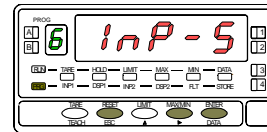

MENU 6  
PIN 5 PROGRAMMING

## MENU 6A - PIN 1 programming

This menu allows selecting the logic function for PIN 1. Available functions are represented by a number from 0 to 28. Consult tables to find the number corresponding to the desired function. The instructions given below apply to pin function 1. Follow the same procedure to configure the rest of the pins.

### [34.1] Menu PIN 1

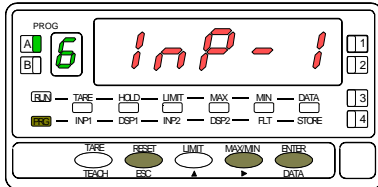

The figure 34.1 shows the indication (InP-1) corresponding to the configuration menu for the PIN 1 function. Press the **ENTER** key to access this configuration.

- ENTER** To access to the programming of the PIN 1 function.
- ▶** To skip over this menu and go to PIN 2.
- ESC** To exit from the programming mode without saving changes.

### [34.2] Function number

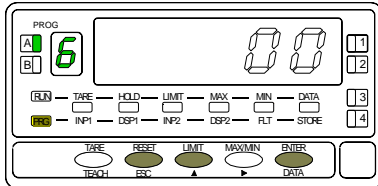

Choose the function number [0-28], according to the table.

- ▲** To change number (hold down to increment automatically).
- ENTER** To save the entry into the memory and return to the run mode.
- ESC** To exit from the programming mode without saving changes.

### 3.5 - PROGRAMMING LOCK OUT. ACCESS LEVELS

Once the instrument programming has been completed, it is recommended to lockout the access in order to prevent from unauthorized or accidental modifications of the setup parameters.

There are 4 lockout levels that are selectable by means of a 2 position DIP-switch located on the main board (see fig. 35.1).

**NOTE :** Remove power before changing the DIP-switch position.

While the instrument is locked out, it is however possible to access the programming routines to check the current configuration, but it won't be possible to input or modify data. In such case a push of **ENTER** from the run mode makes the display show the indication dAtA instead of -Pro-.

Fig. 35.1: DIP-SWITCH

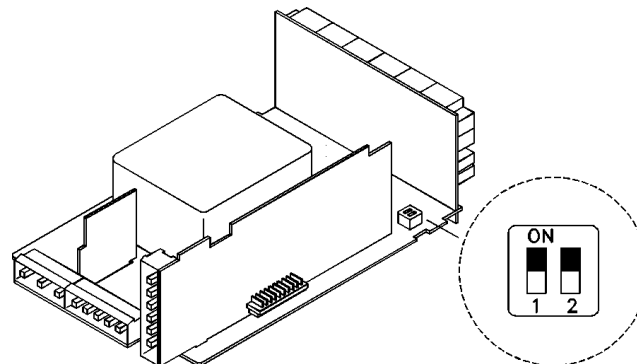

SWITCH	ACCESS LEVELS
<b>1 ON - 2 ON</b>	ACCESS IMPOSSIBLE TO ALL PROGRAMMING LEVELS
<b>1 ON - 2 OFF</b>	ACCESS ALLOWED EXCLUSIVELY TO THE SETPOINTS PROGRAMMING MODULE AND FILTERS
<b>1 OFF - 2 ON</b>	ACCESS ALLOWED TO ALL LEVELS EXCEPT TO THE INPUT CONFIGURATION MODULE
<b>1 OFF - 2 OFF</b>	ACCESS ALLOWED TO ALL PROGRAMMING LEVELS (*)

(\*) Default by factory

## 4. OUTPUT OPTIONS

Optionally, the model ALPHA-L can incorporate one or several output options for communications (this output should never be connected to the telephone lines) or control including :

### COMMUNICATION

RS2	Serial RS232C
RS4	Serial RS485
BCD	BCD 24V/TTL

### CONTROL

ANA	Analogue 4-20mA, 0-10V
2RE	2 SPDT relays 8A
4RE	4 SPST relays 0.5A
4OP	4 open-collector NPN outputs
4OP	4 open-collector PNP outputs

All options are optoisolated with respect to the input signal.

The options are supplied with a specific instructions manual describing characteristics, installation, connections and programming. The output cards are easily installed on the meter's main board by means of plug-in connectors and each one activates its own programming module that provides complete software-configuration.

Additional capabilities of the unit with output options :

- Control and processing of limit values via ON/OFF logic outputs (2 relays, 4 relays, 4 NPN outputs or 4 PNP outputs) or proportional output (4-20mA or 0-10V).
- Communication, data transmission and remote programming via serial interface.

For more detailed information on characteristics, applications, mounting and programming, please refer to the specific manual supplied with each option.

The figure page shows the different locations of the plug-in output cards. Each location corresponds to a specific function: setpoints, analogue and serial outputs.

The options 2RE, 4RE, 4OP and 4OPP are installed in the M5 connector.

The ANA option is installed in the M4 connector.

The options RS2 and RS4 are installed in the M1 connector.

Up to three output options can be present at a time and operate simultaneously, but only one from each category:

- ANALOGUE
- RS232C or RS485
- 2 RELAYS, 4 RELAYS, 4 PNP or 4 NPN

The BCD output is exclusive and do not allow installation of any other card. This option is connected to the main board by means of a 18-pin FLAT cable.

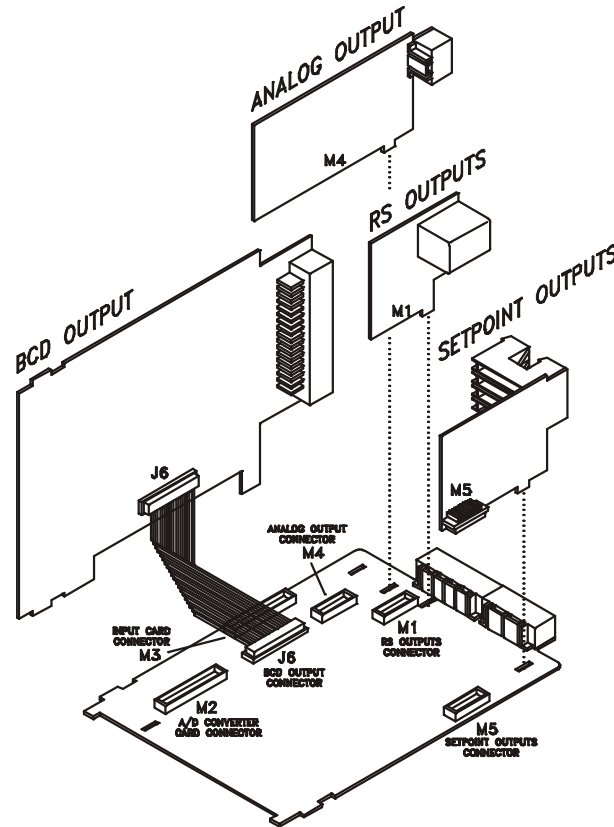

## 4.1 NEW FUNCTIONS

The new ALPHA-L provides improved functionality and incorporates new functions from which the following refer to the output options:

### SETPOINTS

1. Programación de los valores setpoint de +32000 a -32000.
2. New functions :
  - 2.1. Each setpoint can be programmed for auto reset or latched operation. Latched setpoints require a manual reset to deactivate (see logic function 25, page 32). This may be useful when a user action is required on the activation of a setpoint output.
  - 2.2. Each setpoint can be programmed to activate on either the measured value, the peak or the valley.
  - 2.3. Each setpoint may be programmed to blink the display when alarm is active. The LED indicator still lights in either case.
3. Quick access to program the setpoints values.

### RS232

Compatible with ModBus-RTU protocol (see ModBus manual).

### RS485

This output can be used to print several data on a DITEL panel printer (see logic functions page 32).

A new menú ("timE") selects whether to print or not date and time after each print out.

Compatible with ModBus-RTU protocol (see ModBus manual).

### ANALOGUE

See remote inputs, page 32.

### BCD

See remote inputs, pages 31 and 32.

## 5. TECHNICAL SPECIFICATIONS

### INPUT

- Configuration ..... 3 or 4 wires
- Sensibility ..... 0.1 to 999.9 mV / V / mm (Prog)
- Sensor range ..... 0,1 mm to 999,9 mm (Prog)
- Excitation frequency ..... 3,5 kHz or 5kHz(Prog)
- Excitation voltage ..... 1V or 2.2V (Prog)
- Max. current ..... 20mA

### ACCURACY ( Sensor not included )

- Max. error .....  $\pm$  (0.05% of the reading +2 digits)
- Temperature coefficient ..... 100 ppm/ °C
- Warm-up ..... 10 minutes

### FUSES (DIN 41661) - (recommended)

- Alpha-L (230/115V AC) ..... F 0.2A/ 250 V
- Alpha-L1 (10-30V DC) ..... F 2A/ 250 V
- Alpha-L2 (24/48V AC) ..... F 0.5A/ 250 V

### FILTERS

#### Filter P

- Cut -off frequency ..... from 4Hz to 0.05Hz
- Slope ..... from 14 to 37 dB/10

#### Filter E

- Programmable ..... 10 levels

### A/D CONVERSION

- Technique ..... dual slope
- Resolution ..... ( $\pm$ 16 bit)
- Read rate ..... 16/s

### DISPLAY

- Main ..... -32000/32000, 5 digits 14mm red
- Auxiliary ..... 1 digit 7.62mm green
- Decimal pointl ..... programmable
- LEDs ..... 14 (programming and control)
- Display update time ..... 62ms
- Positive overrange ..... +oVFLo
- Negative overrange ..... -oVFLo

### POWER SUPPLY

- AC voltages... 115V/230V, 24V/48V ( $\pm$ 10%) 50/60Hz AC
- DC voltages ..... 10-30V DC
- Consumption ..... 5W (without options), 10W (max.)

### ENVIROMMENTAL

- Operating temperature ..... -10°C to +60°C
- Storage temperature ..... -25°C to +85°C
- Relative humidity ..... <95% to 40°C
- Max. altitude ..... 2000 m

### MECHANICAL

- Dimensions ..... 96x48x120mm
- Panel cutout ..... 92x45mm
- Weight ..... 600g
- Case material ..... polycarbonate s/UL 94 V-0

## 5.1 - Dimensions and mounting

To install the instrument into the panel, make a 92x45mm cutout and insert the instrument into the panel from the front, placing the sealing gasket between this and the front bezel.

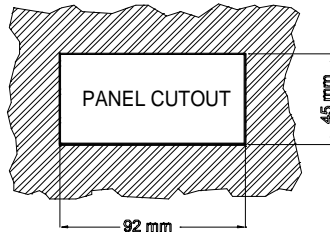

Place the fixing clips on both sides of the case and slide them over the guide tracks until they touch the panel at the rear side.

Press slightly to fasten the bezel to the panel and secure the clips at the retention protrudings.

To take the instrument out of the panel, pull outwards the rear tabs of the fixing clips to disengage and slide them back over the case.

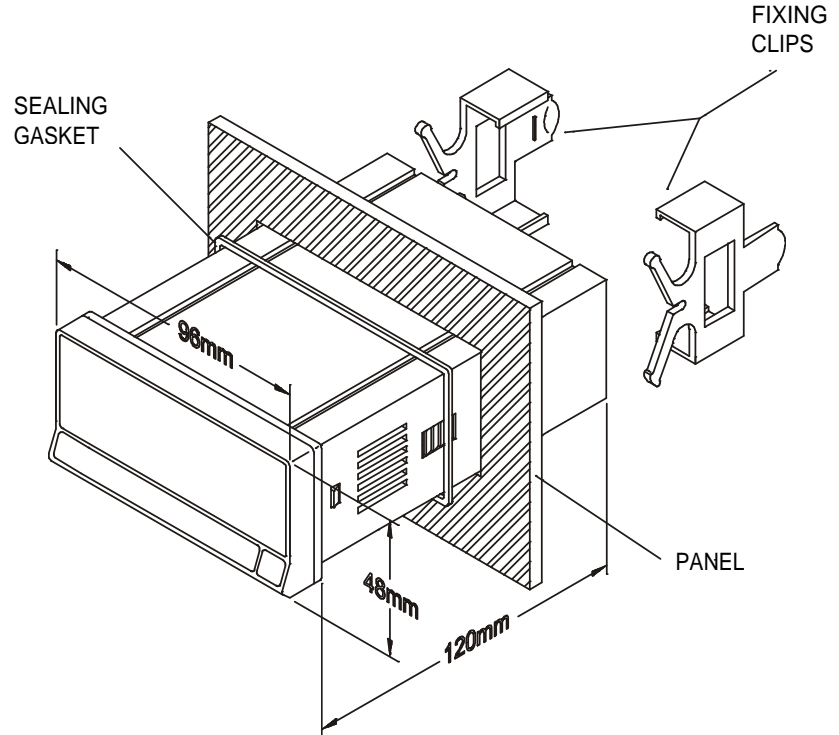

**CLEANING:** The frontal cover should be cleaned only with a soft cloth soaked in neutral soap product.  
**DO NOT USE SOLVENTS**



## 6. WARRANTY

All products are warranted against defective material and workmanship for a period of three years from date of delivery.

If a product appears to have a defect or fails during the normal use within the warranty period, please contact the distributor from whom you purchased the product.

This warranty does not apply to defects resulting from action of the buyer such as mishandling or improper interfacing.

The liability under this warranty shall extend only to the repair of the instrument ; no responsibility is assumed by the manufacturer for any damage which may result from its use.



## 7. DECLARATION OF CONFORMITY

*Manufacturer :* DITEL - Diseños y Tecnología S.A.

*Address :* Travessera de les Corts, 180  
08028 Barcelona  
ESPAÑA

*Declares, that the product :*

Name : Digital panel meter

Model : **ALPHA-L**

*Conforms to :* EMC 89/336/CEE  
LVD 73/23/CEE

Date: 30 November 2000  
Signed: José M. Edo  
Charge: Technical Manager



*Applicable Standards :* **EN50081-1** Generic emission  
EN55022/CISPR22 Class B

*Applicable Standards :* **EN50082-1** Generic immunity  
IEC1000-4-2 Level 3 Criteria B  
Air Discharge 8kV  
Contact Discharge 6kV

IEC1000-4-3 Level 2 Criteria A  
3V/m 80..1000MHz

IEC1000-4-4 Level 2 Criteria B  
1kV Power Lines  
0.5kV Signal Lines

*Applicable Standards :* **EN61010-1** Generic Safety  
Installation Category II  
Transient Voltages <2.5kV  
Pollution Degree 2  
Conductive pollution excluded  
Insulation Type  
Enclosure : Double  
Inputs/Outputs : Basic