

KOSMOS SERIE

CODE: 30727004 EDITION: 27-09-2010

2 of 2



MODEL BETA-M



FIRMWARE
2.00
VERSION

MOD
BUS

FAIL
SAFE

SENSOR
BREAK
ALARM

DITEL

FIRMWARE
2.00
VERSION

**Versions Firmware 2.00
or later**

**MOD
BUS**

Compatible Modbus
See page 86

**FAIL
SAFE**

Fail Safe Function
See page 108

**SENSOR
BREAK
ALARM**

Sensor Break Alarm
See page 107

36

36 Logical Functions
See page 67



Programming parameters lockout
See page 71



Back to Factory Configuration
See page 65



Linearization by segments
See page 36



3 Tare Modes
See page 105

MODEL BETA-M

Index

1 - Beta-M model overview	6 - 7
1.1 Mode RUN: front-panel description.....	8
1.2 Mode PROG: front-panel description.....	9
2 - Getting started.....	10
2.1 Power and connectors.....	11 - 12
2.2 Programming instructions.....	13 - 14
2.3 Programming guide.....	15
3 - Programming module 10. Input configuration diagram	16 - 17
3.1 Program process input. Menu 11.....	18 - 20
3.1.1 Connections (V, mA)	21 - 22
3.2 Program load cell input. Menu 12.....	23 - 24
3.2.1 Connections (mV/ V)	25
3.3 Program Pt100 input. Menu 13	26 - 27
3.3.1 Connections	28
3.4 Program thermocouple input. Menu 14.....	29 - 31
3.4.1 Connections (J, K, T, R, S, E).....	32
3.5 Program potentiometer input. Menu 15	33
3.5.1 Connections.....	33

MODEL BETA-M

4 - Programming module 20. Display configuration diagram	34 - 35
4.1 Scaling. Menus 21 and 22.....	36 - 45
4.2 Integrator. Menu 23.....	46 - 48
4.3 Display options, Filters and Round	49
4.3.1 Display options. Menu 24	50- 51
4.3.2 Filters. Menu 25.....	52 - 53
4.3.3 Round. Menu 26	54
4.4 Automatic volume calculation. Menu 27	55 - 58
5 - Front-panel functions and remote inputs	
5.1 Front-panel functions	59 and 65
5.2 Remote inputs	66
5.2.1 Table of remote input logic functions	67 - 69
5.2.2 Program remote input logic functions.....	70
6 - Programming parameters lockout.....	71
6.1 Lockout routine.....	72
7 - Output options.....	73 - 74
8 - Technical specifications	75 - 76
8.1 Dimensions and mounting	77
9 - Warranty	78
10 - Declaration of conformity	80
ANNEXES. Index.....	82

MAX/MIN key

Recalls the following parameters to the second display : first push recalls peak, second push recalls valley, third push recalls tare (or offset). If the integrator option is enabled, the fourth push recalls total and, if not enabled but the logic function n°30 (totalizer+batch) is programmed to one of the user inputs a new push shows the number of batch operations. The last push after this sequence blanks the lower displays.

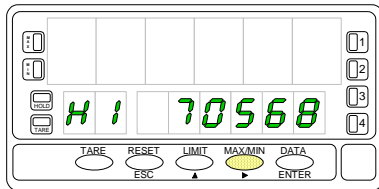

The auxiliary display indicates which variable is being read in the second display : "HI" = peak, "Lo" = valley, "tA" = tare, "oF" = offset, "bA" = n° of batches. The total value needs all 8 digits to be displayed.

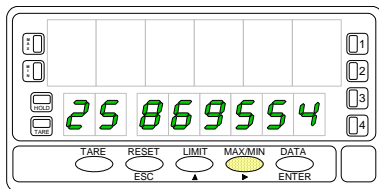

Any selected parameter is permanently displayed and continuously updated if no action is taken.

TO RESET PEAK, VALLEY, TOTAL or BATCH :

RESET key

Press **MAX/MIN** until desired parameter appears on the second display. This parameter may be peak ('HI'), valley ('Lo'), total (auxiliary digits blank or hi part of the total reading) or number of batch operations ('bA').

When desired variable is being read on the lower displays, hold the **RESET** key and press **MAX/MIN**. Release first **MAX/MIN**, then **RESET**.

A tare or tare reset operation updates automatically the peak and valley readings to the current display value.

ENTER key

A momentary push of the ENTER key gives access to the programming mode.

ENTER key (3s)

Gives access to the program lock-out routine. Hold ENTER for approximately 3s, at the end of which the meter prompts the indication '- - -' to enter the security code.

RESET + ENTER (3s)

A press of 3s of both RESET and ENTER restores the factory settings to the memory of the instrument.

Press RESET first, then ENTER and hold both until the indication "StorE" appears on the second display.

5.2 - Logic Functions

The rear connector CN2 provides 4 user programmable opto-coupled inputs that can be operated from external contacts or logic levels supplied by an electronic system. Four different functions may be added to the functions available from the front-panel keys. Each function is associated to one of the CN2 connector pins (PIN 1, PIN 2, PIN 4 and PIN 5) and is activated by applying a falling edge or a low level pulse to the corresponding pin with respect to common (PIN 3). Each pin can be assigned one of the 36 functions listed on the following pages.

Factory Configuration

As shipped from the factory, the CN2 connector allows the TARE, MAX/MIN and RESET operations be made in the same way as from the front-panel keyboard and incorporates one more function: the display HOLD.

If the user programs a '0' (no function) to all input pins, they are automatically set to the default configuration.

CN2 : FACTORY DEFAULT CONFIGURATION

PIN (INPUT)	Function	Number
PIN 1 (INP-1)	RESET	Function n° 7
PIN 2 (INP-2)	HOLD	Function n° 9
PIN 3	COMMON	
PIN 4 (INP-4)	TARE	Function n° 1
PIN 5 (INP-5)	PEAK/VALLEY	Function n° 6

The external electronics (fig.66.2) applied to the CN2 connector must be capable of withstanding 40 V and 20 mA present at all terminals with respect to COMMON. In order to guarantee the electromagnetic compatibility, please refer to the instructions given on page 12.

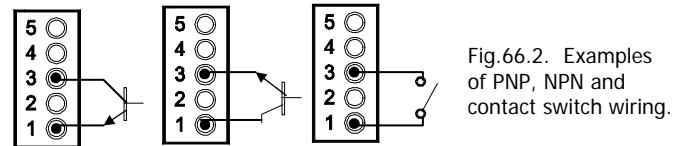
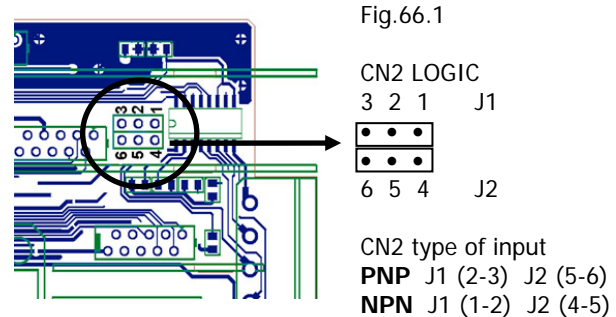

5.2.1 - Table of programmable functions

Definition of the column "Action"

Edge : The function is active when a negative edge is applied to the corresponding pin referred to common.

Level : The function is active as long as the corresponding pin is held at a low level with respect to common.

(*) Factory configuration.

0 to 9 : DISPLAY AND MEMORY FUNCTIONS

N°	Name	Function	Action
0	NO	None	-
1	TARE (*)	Adds the current display value to the tare memory	Edge
2	RESET TARE	Clears the tare memory	Edge
3	PEAK	Recalls the peak value	Level
4	VALLEY	Recalls the valley value	Level
5	RESET PEAK/VALLEY	Resets peak and valley readings	Edge
6	VISUAL (*)	Recalls various parameters to the second display; Peak, Valley, Tare or Offset and, if they are active, the Totalizer and the Batch counters. The last action blanks the second display.	Edge
7	RESET (*)	In combination with function (1) clears the tare memory. In combination with function (6) clears the peak or valley memories, or the totalizer or the batch counter	Edge
8	HOLD1	Holds the display	Level
9	HOLD2 (*)	Holds the display and the analog and BCD outputs	Level

10 to 12 : FUNCTIONS ASSOCIATED WITH THE MEASUREMENT DISPLAY

N°	Name	Function	Action
10	INPUT	Displays the signal input value in V or mA, mV or mV from TC or ohms from Pt100	Level
11	GROSS	Displays the gross value (measurement value + tare subtracted)	Level
12	TARE	Displays the value of the tare memory	Level

13 to 16 : FUNCTIONS ASSOCIATED TO THE ANALOG OUTPUT

N°	Name	Function	Action
13	ANA GROSS	The analog output follows the gross value (measured value + tare).	Level
14	ANA ZERO	Puts the analog output to the zero state (0V or 4mA)	Level
15	ANA PEAK	The analog output follows the peak value	Level
16	ANA VALLEY	The analog output follows the valley value	Level

17 to 23 : PRINT FUNCTIONS TO USE WITH RS232C or RS485 OUTPUTS

N°	Name	Function	Action
17	PRINT NET	Prints the net value	Edge
18	PRINT GROSS	Prints the gross value	Edge
19	PRINT TARE	Prints the value of the tare	Edge
20	PRINT SET1	Prints the value and the state of the setpoint 1	Edge
21	PRINT SET2	Prints the value and the state of the setpoint 2	Edge
22	PRINT SET3	Prints the value and the state of the setpoint 3	Edge
23	PRINT SET4	Prints the value and the state of the setpoint 4	Edge

24 to 25 : FUNCTIONS ASSOCIATED WITH THE SETPOINT OUTPUTS

N°	Name	Function	Action
24	FALSE SETPOINTS	Allows programming and operation of four setpoints without setpoint card installed	Level
25	RESET SETPOINTS	Unlocks the setpoint latched outputs	Edge

26 to 36 : SPECIAL FUNCTIONS

N°	Name	Function	Action
26	ROUND RS	Makes the serial output transmit the internal display value, without filters nor rounding	Level
27	ROUND BCD	Makes the BCD output drive out the display value without rounding	Level

26 to 36 : SPECIAL FUNCTIONS (cont.)

N°	Name	Function	Action
28	ASCII	Send the display last four digits to a Micra-S indicator	Edge
29	SETS INHIBIT	Suspends setpoint operations and keeps the outputs to their OFF state	Level
30	BATCH	Adds the current display value to the totalizer and increments the batch counter in one unit. If the integrator is enabled (menu 23), this function does not work	Edge
31	VIEW TOTAL	Calls the totalizer value to the second display	Level
32	VIEW BATCH	Calls the batch counter to the second display	Level
33	RESET TOTAL+BATCH	Resets the totalizer and the batch counter	Edge
34	STOP TOTAL	Inhibits the integrator operation	Level
35	PRINT TOTAL+BATCH	Prints out the totalizer value and the batch counter value. If the integrator is enabled, only the totalizer value is printed.	Edge
36	PRINT PEAK	Hold and print max reading. When this function is programmed the peak value detection is stopped. In the activation edge, the peak register is cleared from the memory and the unit starts reading new peak values. In the deactivation edge, the peak value registered during the time the function was active is printed out through the serial output	Level

5.2.2 - Program the logic functions

Press **ENTER** to enter in the programming mode (-Pro- level) and press repeatedly **▶** until the indication shown in figure 70.1 appears on the display. From this stage press **ENTER** to access the logic inputs configuration. The **▶** key rotates around the four logic inputs to view the function number assigned to each pin. The **▲** key changes the number if desired.

To program the logic inputs follow the procedure described below for input 1.

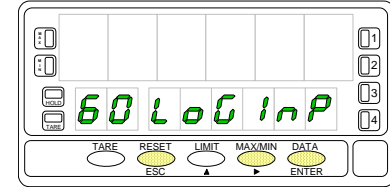
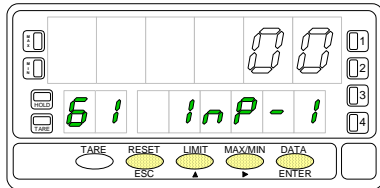

Fig. 70.1: Logic inputs configuration module

Menu 61 - Program Logic Input 1

[70.2] Logic input PIN 1



Menu 61 Inp-1. Assign logic function to PIN 1.

The main display shows the function number assigned to logic input 1. Refer to the table to select function and use the **▲** key to change the number if desired.

- ▶** Pass to the programming of the following logic input.
- ENTER** Validate changes and return to the -Pro- stage.
- ESC** Exit from this menu and go to the -Pro- stage.

6. PARAMETER LOCKOUTS

The instrument is supplied with all software programming parameters accessible to operator's modifications. After completing the software configuration, it is recommended to take the following steps:

1. Lockout programming parameters to prevent from accidental or unauthorized modifications.
2. Lockout the tare key operation.
3. The lockout can be applied to everything or to specific menus or parameters. If some parameters should be reprogrammed frequently, make a partial lock leaving such parameters accessible. If no subsequent adjust must be made, make a total lock.
4. The access to the lockout routine is allowed by entering a safety code. At fabrication this code is set to 0000. We recommend to change this code and to write it down and keep safe.
5. Prior to configure the meter, it is recommended to organize all data and keep a record s manual.

TOTAL LOCKOUT

The access to the programming routines to read data is allowed even if all parameters are locked out, but **it won't be possible to enter or modify data**. In this case, when entering in the programming mode, the second display shows the indication -dAtA- instead of -Pro-.

SELECTIVE LOCKOUT

When only some parameters are locked out, all configuration data can be read but **only non-protected parameters can be modified**. In such case, when entering in the programming mode, the second display shows the indication -Pro-.

Selective lock-outs include the following groups:

- Setpoint 1 configuration (menu 31).
- Setpoint 2 configuration (menu 32).
- Setpoint 3 configuration (menu 33).
- Setpoint 4 configuration (menu 34).
- Input configuration (module 10).
- Scaling (menus 21/22, 23 and 27).
- Display options and filtering (menus 24, 25 and 26).
- Analog output configuration (module 40).
- Serial output configuration (module 50).
- Logic inputs configuration (module 60).
- Direct access to the programming of the setpoint values

Those that refer to optional outputs only appear if the corresponding option is installed.

6.1 - Lockout programming routine

The lock-out programming routine is entered by depressing the **ENTER** key for 3 seconds and introducing a security code. This gives access to either the parameter list or to change the code if desired.

If the user opts for changing the code, the unit asks for the new one and returns to the normal operation. The old code is replaced with the user selected one, that will be asked next time this routine is entered.

When the user enters the parameter list, each parameter is indicated in the second display, while in the first one a blinking digit allows setting a '1' to lock this item, or a '0' to free it.

There are two ways to lock-out the program; One is to lock everything, which is accomplished by setting a '1' in the 'tot-LC' parameter (the remaining parameters are skipped except the tare key lock).

The second is to individually lock some parts of the program menus leaving free those parts which are more liable to have changes during normal operation.

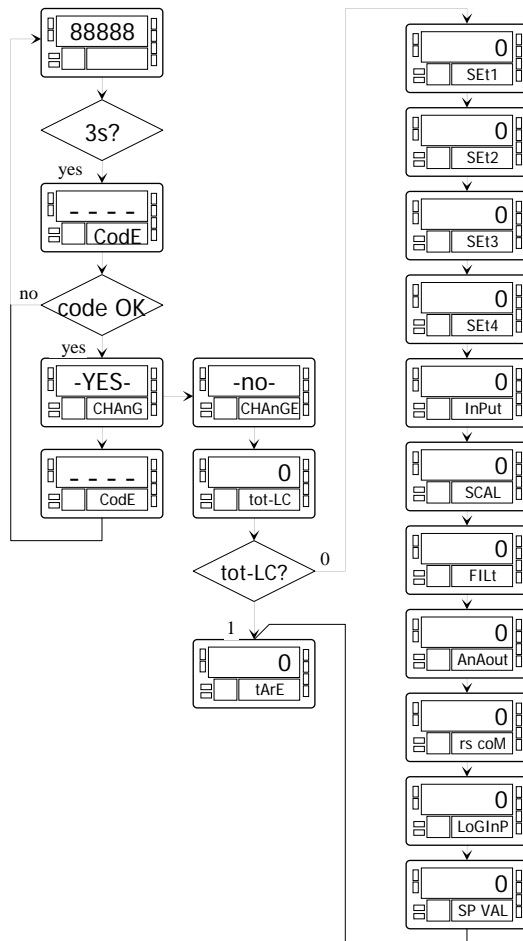

7. OUTPUT OPTIONS

Output options with instructions manual edited before December 1999, work properly with new versions of Beta-M but some new features may not be described in the options manual.

If you are using an older output card connected to a new Beta-M and you want to take benefit of the new functions (see page 60), please call for an updated edition of the options manual.

Optionally, model BETA-M can incorporate one or several output options for communications or control including :

COMMUNICATION

RS2	Serial RS232C
RS4	Serial RS485
BCD	BCD 24V/TTL

CONTROL

ANA	Analogue 4-20 mA, 0-10 V
2RE	2 SPDT relays 8 A
4RE	4 SPST relays 5 A
4OP	4 open-collector NPN outputs
4OPP	4 open-collector PNP outputs

All options are optoisolated with respect to the input signal.

The options are supplied with a specific instructions manual describing characteristics, installation, connections and programming. The output cards are easily installed on the meter's main board by means of plug-in connectors and each one activates its own programming module that provides complete software-configuration.

Additional capabilities of the unit with output options :

- Control and processing of limit values via ON/OFF logic outputs (2 relays, 4 relays, 4 NPN outputs or 4 PNP outputs) or proportional output (4-20 mA or 0-10 V).
- Communication, data transmission and remote programming via serial interface.

For more detailed information on characteristics, applications, mounting and programming, please refer to the specific manual supplied with each option.

The figure shows the main circuit board locations of the available output options. Each plug-in location can accept only one card from a particular function type.

The options 2RE, 4RE, 4OP and 4OPP are for setpoint control and only one of them can be installed in the M5 location.

The options RS2 and RS4 are for communication and only one of them can be installed in the M1 location.

The ANA option provides selectable 0-10V and 20mA analog output and is installed in the M4 location.

Up to three output options can be present at a time and operate simultaneously:

- ANALOGUE, 0-10V or 4-20mA
- RS232C or RS485 (one of them),
- 2 RELAYS, 4 RELAYS or 4 NPN or 4 PNP outputs (one of them).

The BCD output is exclusive and it does not allow any of the others. This option is attached to the main circuit board by means of a 18-pin FLAT cable.

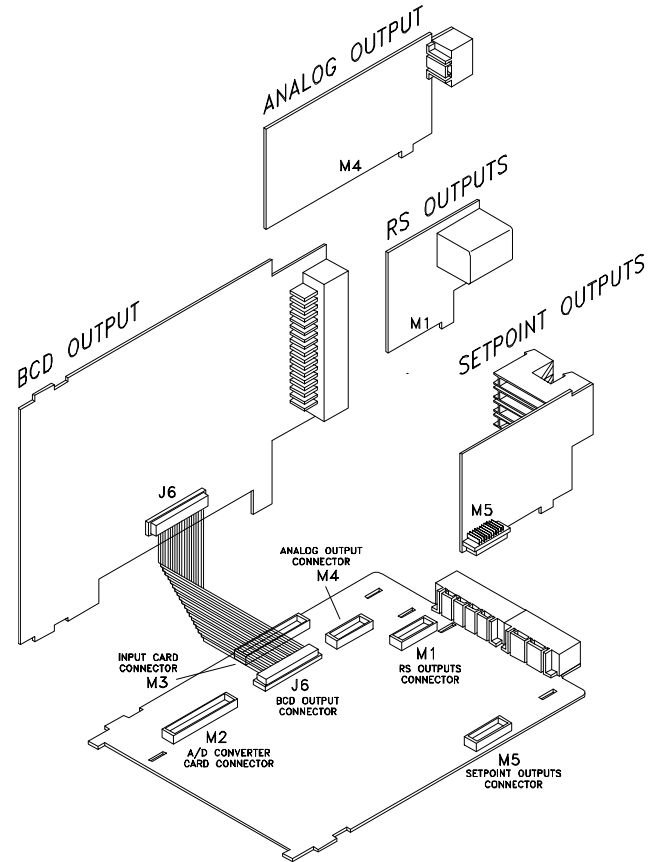

8. TECHNICAL SPECIFICATIONS

INPUT SIGNAL

- Configuration differential asymmetrical

Process input	Voltage	Current
• Voltage	$\pm 10\text{V DC}$	$\pm 20\text{mA DC}$
• Max. resolution.....	0.1mV	$1\mu\text{A}$
• Input impedance	$1\text{M}\Omega$	15Ω
• Excitation	$24\text{V (30mA), 10/ 5V (120mA)}$	
• Max error	$\pm (0.1\% \text{ of the reading} + 3 \text{ digits})$	
• Temperature coefficient	$100 \text{ ppm/ } ^\circ\text{C}$	

Load cell input

- Voltage $\pm 300 \text{ mV DC}$
- Max. resolution..... $0.15 \mu\text{V}$
- Input impedance $100 \text{ M}\Omega$
- Excitation $10/ 5\text{V (120 mA)}$
- Max error $\pm (0.1\% \text{ of the reading} + 6 \text{ digits})$
- Temperature coefficient $100 \text{ ppm/ } ^\circ\text{C}$

Potentiometer input

- Voltage $\pm 10\text{V DC}$
- Input impedance $1\text{M}\Omega$
- Display resolution 0.001%
- Max error $\pm (0.1\% \text{ of the reading} + 3 \text{ digits})$
- Temperature coefficient $100 \text{ ppm/ } ^\circ\text{C}$

Temperature input

- Cold junction compensation..... $-10 ^\circ\text{C}$ to $+60 ^\circ\text{C}$
- Cold junction $\pm(0.05 ^\circ\text{C/ } ^\circ\text{C} + 0.1 ^\circ\text{C})$
- Pt100 excitation current $< 1 \text{ mA DC}$
- Max. cable resistance $40 \Omega/ \text{ cable (balanced)}$
- Temperature coefficient $100 \text{ ppm/ } ^\circ\text{C}$

Input	Range (0.1 $^\circ$)	Accuracy (0.1 $^\circ$)	Range (1 $^\circ$)	Accuracy (1 $^\circ$)
TC J	-200.0 to +1100.0 $^\circ\text{C}$	0.4% L $\pm 0.6 ^\circ\text{C}$	-200 to +1100 $^\circ\text{C}$	0.4% L $\pm 1 ^\circ\text{C}$
	-328.0 to +2012.0 $^\circ\text{F}$	0.4% L $\pm 1 ^\circ\text{F}$	-328 to +1472 $^\circ\text{F}$	0.4% L $\pm 2 ^\circ\text{F}$
TC K	-200.0 to +1200.0 $^\circ\text{C}$	0.4% L $\pm 0.6 ^\circ\text{C}$	-200 to +1200 $^\circ\text{C}$	0.4% L $\pm 1 ^\circ\text{C}$
	-328.0 to +2192.0 $^\circ\text{F}$	0.4% L $\pm 1 ^\circ\text{F}$	-328 to +2192 $^\circ\text{F}$	0.4% L $\pm 2 ^\circ\text{F}$
TC T	-150.0 to +400.0 $^\circ\text{C}$	0.4% L $\pm 0.6 ^\circ\text{C}$	-150 to +400 $^\circ\text{C}$	0.4% L $\pm 1 ^\circ\text{C}$
	-302.0 to +752.0 $^\circ\text{F}$	0.4% L $\pm 1 ^\circ\text{F}$	-302 to +752 $^\circ\text{F}$	0.4% L $\pm 2 ^\circ\text{F}$
TC R	-50.0 to 1700.0 $^\circ\text{C}$	0.5% L $\pm 2 ^\circ\text{C}$	-50 to 1700 $^\circ\text{C}$	0.5% L $\pm 4 ^\circ\text{C}$
	-58.0 to +3092.0 $^\circ\text{F}$	0.5% L $\pm 4 ^\circ\text{F}$	-58 to +3092 $^\circ\text{F}$	0.5% L $\pm 7 ^\circ\text{F}$
TC S	-50.0 to 1700.0 $^\circ\text{C}$	0.5% L $\pm 2 ^\circ\text{C}$	-50 to 1700 $^\circ\text{C}$	0.5% L $\pm 4 ^\circ\text{C}$
	-58.0 to +3092.0 $^\circ\text{F}$	0.5% L $\pm 4 ^\circ\text{F}$	-58 to +3092 $^\circ\text{F}$	0.5% L $\pm 7 ^\circ\text{F}$
TC E	-200.0 to 1000.0 $^\circ\text{C}$	0.4% L $\pm 1 ^\circ\text{C}$	-200 to 1000 $^\circ\text{C}$	0.4% L $\pm 2 ^\circ\text{C}$
	-328.0 to +1832.0 $^\circ\text{F}$	0.4% L $\pm 2 ^\circ\text{F}$	-328 to +1832 $^\circ\text{F}$	0.4% L $\pm 4 ^\circ\text{F}$
Pt100	-100.0 to +800.0 $^\circ\text{C}$	0.2% L $\pm 0.6 ^\circ\text{C}$	-100 to +800 $^\circ\text{C}$	0.2% L $\pm 1 ^\circ\text{C}$
	-148.0 to +1472.0 $^\circ\text{F}$	0.2% L $\pm 1 ^\circ\text{F}$	-148 to +1472 $^\circ\text{F}$	0.2% L $\pm 2 ^\circ\text{F}$

ELECTRICAL SAFETY

- Installation category II
- Degree of pollution 2

FUSES (DIN 41661) - Not supplied

- Beta-M (230/115V AC) F 0.2 A / 250 V
- Beta-M2 (24/48V AC) F 0.5 A / 250 V

A/D CONVERSION

- Technique Sigma-Delta
- Resolution (24 bit)
- Rate 18/s

ACCURACY at 23° ± 5° C

- Temperature coefficient 100 ppm/ °C
- Warm-up time 10 min

POWER SUPPLY

- AC voltages 230/115 V, 24/48 V (±10%) 50/60 Hz AC
- Consumption 5W (without options), 10W (max)

DISPLAY

- Main -99999/ +99999, 6 digits red LED 14 mm
- Secondary 6 digits green LED 8 mm
- Auxiliary 2 digits green LED 8 mm
- Decimal point programmable
- LEDs 4 functions and 4 output status
- Reading rate 55.5 ms/ 250 ms/ 1 s
- Positive overrange oVFLo
- Negative overrange -oVFLo
- Sensor Break "-----"

ENVIRONMENTAL

(indoor use)

- Operating temperature -10 °C to +60 °C
- Storage temperature -25 °C to +85 °C
- Relative humidity <95 % at 40 °C
- Max. altitude 2000 meters

MECHANICAL

- Dimensions 96x48x120 mm
- Panel cutout 92x45 mm
- Weight 600 g
- Case material UL 94 V-0 rated polycarbonate

8.1 - Dimensions and mounting

To mount the instrument into the panel, make a cutout of 92x45mm. Slide the sealing gasket over the instrument's case to the bezel and insert the instrument through the panel cutout from the front.

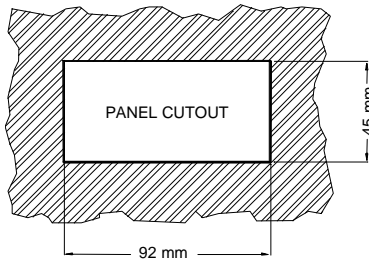

Place the fixing clips on both sides of the case and push them over the rear until they touch the panel. Apply pressure to engage the tabs on the fixing clips to the slots of the case.

To remove the instrument from the panel, pull outwards the fixing clips from the rear tabs to disengage and slide them back over the case.

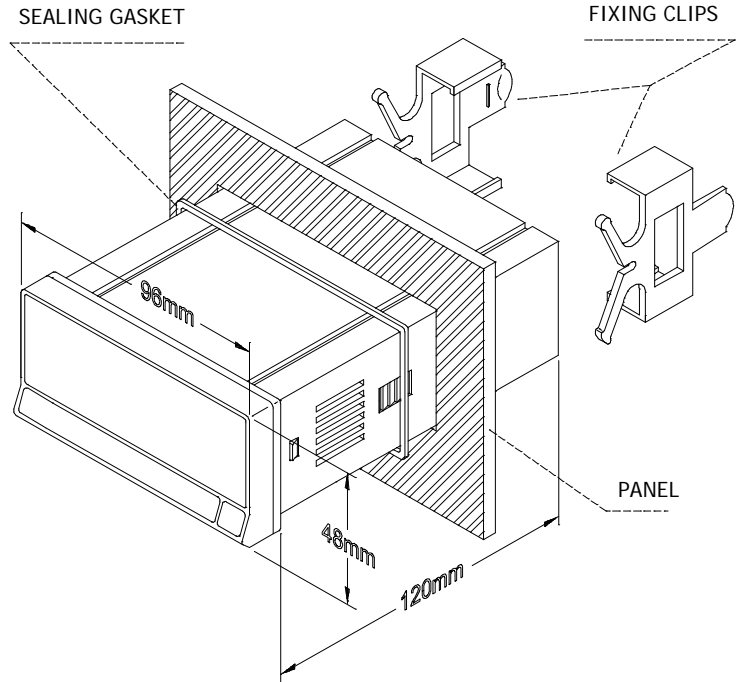

CLEANING: The front cover should be cleaned only with a soft cloth soaked in neutral soap products. DO NOT USE SOLVENTS



The instruments are warranted against defective materials and workmanship for a period of three years from date of delivery.

If a product appears to have a defect or fails during the normal use within the warranty period, please contact the distributor from which you purchased the product.

This warranty does not apply to defects resulting from action of the buyer such as mishandling or improper interfacing.

The liability under this warranty shall extend only to the repair of the instrument. No responsibility is assumed by the manufacturer for any damage which may result from its use.



All the DITEL products benefit from an unlimited and unconditional warranty of THREE (3) years from the date of their purchase. Now you can extend this period of warranty up to FIVE (5) years from the product commissioning, only by fulfilling the corresponding form.

Fill up the form in our website at:
<http://www.ditel.es/warranty>

10. DECLARATION OF CONFORMITY

Manufacturer : DITEL - Diseños y Tecnología S.A.

Address : Polígono Industrial Les Guixeres
C/ Xarol 8 C
08915 BADALONA-SPAIN

Declares, that the product :

Description : Digital panel multifunction meter

Model : **BETA-M**

Conforms with the directives : EMC 2004/108/CEE
LVD 2006/95/CEE

Date: 20 July 2010

Signed: José M. Edo

Position: Technical Manager



Applicable Standards : **EN50081-1** Generic emission
EN55022/CISPR22 Class B

Applicable Standards : **EN50082-1** Generic immunity
IEC1000-4-2 Level 3 Criteria B
Air Discharge 8kV
Contact Discharge 6kV

IEC1000-4-3 Level 2 Criteria A
3V/m 80..1000MHz

IEC1000-4-4 Level 2 Criteria B
1kV Power Lines
0.5kV Signal Lines

Applicable Standards : **EN61010-1** Generic Safety
Installation Category II
Transient Voltages <2.5kV
Pollution Degree 2
Conductive pollution excluded
Insulation Type
Enclosure : Double
Inputs/Outputs : Basic

Index

SECTION	Page
ANNEXE A. SETPOINTS	83
ANNEXE B. SERIAL OUTPUTS RS232C AND RS485	
B.1. List of Commands	84 to 85
B.2. Address of the Variables in the memory	86 to 103
ANNEXE C.	
c1. TARE MODE	105 to 106
c2. Sensor break	107
c3. Fail SAFE in Setpoints menu	108
c4. r.o.C. in Setpoints menu	109
c5. doSE function in Setpoints menu	110

ANNEXE A. SETPOINTS

The following functions have been added:

1. Use setpoint 2 to detect max reading

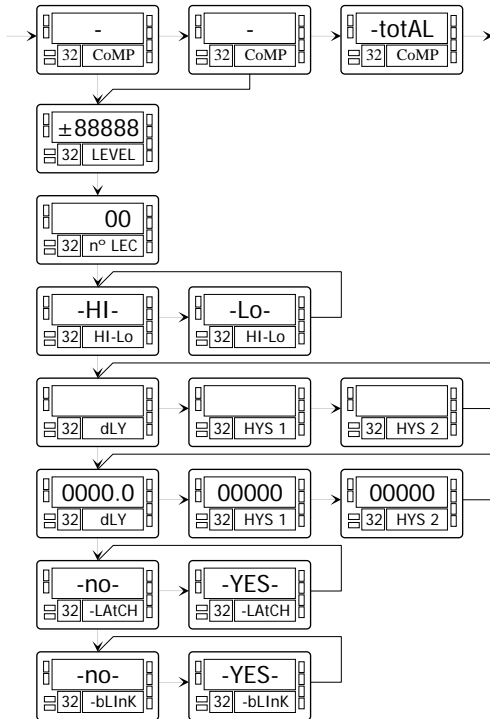

The option 'MAX' is for non-filtered peak values and the option 'MAX-F' is for filtered values.

The setpoint configuration options (latch, HI-LO mode, delay-hysteresis, blink) are programmed as for a standard setpoint but some have different meanings in this case, the setpoint value is the display value from which the unit begins to read peaks, below this value the operation is disabled.

The delay/hysteresis value is the amount of time that the output will stay active from the moment that a peak value is detected (except in mode latch).

The output activation occurs when the instrument detects that the measured variable has stopped increasing its magnitude and is falling down or stable for a number of readings programmable from 0 to 99.

The 'n°-LEC' parameter allows to program the number of readings to wait from the last peak detection, before the input variable can be considered to grow up no more (the instrument makes 16 readings per second).

2. Control the setpoint outputs by a command via RS232C or RS485

This facility is enabled by selecting the option 'CoM' in the setpoint on-off menu level. The rest of the standard setpoint options are omitted in the programming routine except selection of the display blink. The output status of these setpoints cannot be changed by an overflow condition or a pass to the programming mode.

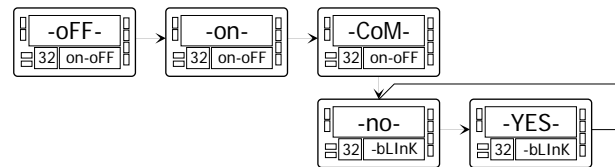

3. The setpoints can be referred to the totalizer value

In this case the setpoint value is programmed in the second display. The rest of the options are the same as for a standard setpoint.

ANNEXE B. SERIAL OUTPUT RS232C or RS485

B.1. List of Commands

REQUEST OF DATA

ASCII	ISO	Information
I	0I	Logic inputs status
P	0P	Peak value
V	0V	Valley value
T	0T	Tare/Offset value
D	0D	Display value
Z	0Z	Totalizer value
X	0X	Batch counter value
L1	L1	Value of the setpoint1
L2	L2	Value of the setpoint2
L3	L3	Value of the setpoint3
L4	L4	Value of the setpoint4
E	0E	Bit 0=input overflow, bit 1= scale overflow, bit 2= Sensor break

MODIFICATION OF DATA

ASCII	ISO	Parameter
M1	M1	Change the setpoint1 value in the memory
M2	M2	Change the setpoint2 value in the memory
M3	M3	Change the setpoint3 value in the memory
M4	M4	Change the setpoint4 value in the memory
S1	S1	Change the setpoint1 value (not stored in memory)
S2	S2	Change the setpoint1 value (not stored in memory)
S3	S3	Change the setpoint1 value (not stored in memory)
S4	S4	Change the setpoint1 value (not stored in memory)

COMMANDS

ASCII	ISO	MODBUS	Command
n	0n	n	Reset latched outputs
p	0p	p	Reset peak
v	0v	v	Reset valley
r	0r	r	Reset tare
t	0t	t	Tare the display
z	0z	z	Reset totalizer
x	0x	x	Reset batch counter
a1	a1	a1	Activate setpoint1
a2	a2	a2	Activate setpoint2
a3	a3	a3	Activate setpoint3
a4	a4	a4	Activate setpoint4
d1	d1	d1	Deactivate setpoint1
d2	d2	d2	Deactivate setpoint2
d3	d3	d3	Deactivate setpoint3
d4	d4	d4	Deactivate setpoint4

B.2. Address of the Variables in the Memory

PROGRAMMING DATA (READ/WRITE)

ISO	MODBUS	Variable	Description
0	0	INPUT POINT 1	Sign 0=+,A=-
1			digit 4
2			digit 3
3			digit 2
4			digit 1
5	2	digit 0	
6	3	INPUT POINT 2	sign
7			digit 4
8	4	INPUT POINT 2	digit 3
9			digit 2
10	5	INPUT POINT 2	digit 1
11			digit 0
12	6	INPUT POINT 3	sign
13			digit 4
14	7	INPUT POINT 3	digit 3
15			digit 2
16	8	INPUT POINT 3	digit 1
17			digit 0
18	9	INPUT POINT 4	sign
19			digit 4
20	10	INPUT POINT 4	digit 3
21			digit 2
22	11	INPUT POINT 4	digit 1
23			digit 0
24	12	INPUT POINT 5	sign
25			digit 4
26	13	INPUT POINT 5	digit 3
27			digit 2
28	14	INPUT POINT 5	digit 1
29			digit 0

30	15	INPUT POINT 6	sign
31			digit 4
32	16		digit 3
33			digit 2
34	17		digit 1
35			digit 0
36	18	INPUT POINT 7	sign
37			digit 4
38	19		digit 3
39			digit 2
40	20		digit 1
41			digit 0
42	21	INPUT POINT 8	sign
43			digit 4
44	22		digit 3
45			digit 2
46	23		digit 1
47			digit 0
48	24	INPUT POINT 9	sign
49			digit 4
50	25		digit 3
51			digit 2
52	26		digit 1
53			digit 0
54	27	INPUT POINT 10	sign
55			digit 4
56	28		digit 3
57			digit 2
58	29		digit 1
59			digit 0
60	30	INPUT POINT 11	sign
61			digit 4
62	31		digit 3
63			digit 2
64	32		digit 1
65			digit 0

66	33	INPUT POINT 12	sign
67			digit 4
68	34		digit 3
69			digit 2
70	35		digit 1
71			digit 0
72	36	INPUT POINT 13	sign
73			digit 4
74	37		digit 3
75			digit 2
76	38		digit 1
77			digit 0
78	39	INPUT POINT 14	sign
79			digit 4
80	40		digit 3
81			digit 2
82	41		digit 1
83			digit 0
84	42	INPUT POINT 15	sign
85			digit 4
86	43		digit 3
87			digit 2
88	44		digit 1
89			digit 0
90	45	INPUT POINT 16	sign
91			digit 4
92	46		digit 3
93			digit 2
94	47		digit 1
95			digit 0
96	48	INPUT POINT 17	sign
97			digit 4
98	49		digit 3
99			digit 2
100	50		digit 1
101			digit 0

102	51	INPUT POINT 18	sign
103			digit 4
104	52		digit 3
105			digit 2
106	53		digit 1
107			digit 0
108	54		INPUT POINT 19
109	55	digit 4	
110		digit 3	
111	digit 2		
112	56	digit 1	
113		digit 0	
114	57	INPUT POINT 20	
115	58		digit 4
116			digit 3
117	digit 2		
118	59		digit 1
119			digit 0
120	60		INPUT POINT 21
121	61	digit 4	
122		digit 3	
123	digit 2		
124	62	digit 1	
125		digit 0	
126	63	INPUT POINT 22	
127	64		digit 4
128			digit 3
129	digit 2		
130	65		digit 1
131			digit 0
132	66		INPUT POINT 23
133	67	digit 4	
134		digit 3	
135	digit 2		
136	68	digit 1	
137		digit 0	

138	69	INPUT POINT 24	sign
139			digit 4
140	70		digit 3
141			digit 2
142	71		digit 1
143			digit 0
144	72	INPUT POINT 25	sign
145			digit 4
146	73		digit 3
147			digit 2
148	74		digit 1
149			digit 0
150	75	INPUT POINT 26	sign
151			digit 4
152	76		digit 3
153			digit 2
154	77		digit 1
155			digit 0
156	78	INPUT POINT 27	sign
157			digit 4
158	79		digit 3
159			digit 2
160	80		digit 1
161			digit 0
162	81	INPUT POINT 28	sign
163			digit 4
164	82		digit 3
165			digit 2
166	83		digit 1
167			digit 0
168	84	INPUT POINT 29	sign
169			digit 4
170	85		digit 3
171			digit 2
172	86		digit 1
173			digit 0

174	87	INPUT POINT 30	sign
175			digit 4
176	88		digit 3
177			digit 2
178	89		digit 1
179		digit 0	
180	90	DISPLAY POINT 1	sign
181			digit 4
182	91		digit 3
183			digit 2
184	92		digit 1
185		digit 0	
186	93	DISPLAY POINT 2	sign
187			digit 4
188	94		digit 3
189			digit 2
190	95		digit 1
191		digit 0	
192	96	DISPLAY POINT 3	sign
193			digit 4
194	97		digit 3
195			digit 2
196	98		digit 1
197		digit 0	
198	99	DISPLAY POINT 4	sign
199			digit 4
200	100		digit 3
201			digit 2
202	101		digit 1
203		digit 0	
204	102	DISPLAY POINT 5	sign
205			digit 4
206	103		digit 3
207			digit 2
208	104		digit 1
209		digit 0	

210	105	DISPLAY POINT 6	sign
211			digit 4
212	106		digit 3
213			digit 2
214	107		digit 1
215		digit 0	
216	108	DISPLAY POINT 7	sign
217			digit 4
218	109		digit 3
219			digit 2
220	110		digit 1
221		digit 0	
222	111	DISPLAY POINT 8	sign
223			digit 4
224	112		digit 3
225			digit 2
226	113		digit 1
227		digit 0	
228	114	DISPLAY POINT 9	sign
229			digit 4
230	115		digit 3
231			digit 2
232	116		digit 1
233		digit 0	
234	117	DISPLAY POINT 10	sign
235			digit 4
236	118		digit 3
237			digit 2
238	119		digit 1
239		digit 0	
240	120	DISPLAY POINT 11	sign
241			digit 4
242	121		digit 3
243			digit 2
244	122		digit 1
245		digit 0	

246	123	DISPLAY POINT 12	sign
247	124		digit 4
248			digit 3
249	125		digit 2
250			digit 1
251		digit 0	
252	126	DISPLAY POINT 13	sign
253	127		digit 4
254			digit 3
255	128		digit 2
256			digit 1
257		digit 0	
258	129	DISPLAY POINT 14	sign
259	130		digit 4
260			digit 3
261	131		digit 2
262			digit 1
263		digit 0	
264	132	DISPLAY POINT 15	sign
265	133		digit 4
266			digit 3
267	134		digit 2
268			digit 1
269		digit 0	
270	135	DISPLAY POINT 16	sign
271	136		digit 4
272			digit 3
273	137		digit 2
274			digit 1
275		digit 0	
276	138	DISPLAY POINT 17	sign
277	139		digit 4
278			digit 3
279	140		digit 2
280			digit 1
281		digit 0	

282	141	DISPLAY POINT 18	sign
283			digit 4
284	142		digit 3
285			digit 2
286	143		digit 1
287			digit 0
288	144		DISPLAY POINT 19
289	145	digit 4	
290		digit 3	
291	146	digit 2	
292		digit 1	
293		digit 0	
294	147	DISPLAY POINT 20	
295	148		digit 4
296			digit 3
297	149		digit 2
298			digit 1
299			digit 0
300	150		DISPLAY POINT 21
301	151	digit 4	
302		digit 3	
303	152	digit 2	
304		digit 1	
305		digit 0	
306	153	DISPLAY POINT 22	
307	154		digit 4
308			digit 3
309	155		digit 2
310			digit 1
311			digit 0
312	156		DISPLAY POINT 23
313	157	digit 4	
314		digit 3	
315	158	digit 2	
316		digit 1	
317		digit 0	

318	159	DISPLAY POINT 24	sign
319			digit 4
320	160		digit 3
321			digit 2
322	161		digit 1
323		digit 0	
324	162	DISPLAY POINT 25	sign
325			digit 4
326	163		digit 3
327			digit 2
328	164		digit 1
329		digit 0	
330	165	DISPLAY POINT 26	sign
331			digit 4
332	166		digit 3
333			digit 2
334	167		digit 1
335		digit 0	
336	168	DISPLAY POINT 27	sign
337			digit 4
338	169		digit 3
339			digit 2
340	170		digit 1
341		digit 0	
342	171	DISPLAY POINT 28	sign
343			digit 4
344	172		digit 3
345			digit 2
346	173		digit 1
347		digit 0	
348	174	DISPLAY POINT 29	sign
349			digit 4
350	175		digit 3
351			digit 2
352	176		digit 1
353		digit 0	

354	177	DISPLAY POINT 30	sign
355	178		digit 4
356			digit 3
357	179		digit 2
358			digit 1
359		digit 0	
360	180	SETPOINT 1	digit 7 / sign
361	181		digit 6
362			digit 5
363	182		digit 4
364			digit 3
365			digit 2
366	183		digit 1
367		digit 0	
368	184	SETPOINT 2	digit 7 / sign
369	185		digit 6
370			digit 5
371	186		digit 4
372			digit 3
373			digit 2
374	187		digit 1
375			digit 0
376	188	SETPOINT 3	digit 7 / sign
377	189		digit 6
378			digit 5
379	190		digit 4
380			digit 3
381			digit 2
382	191		digit 1
383		digit 0	
384	192	SETPOINT 4	digit 7 / sign
385	193		digit 6
386			digit 5
387	194		digit 4
388			digit 3
389			digit 2

390	195		digit 1
391			digit 0
392	196	DELAY / HYSTERESIS SETPOINT 1	digit 4
393			digit 3
394	197		digit 2
395			digit 1
396	198	DELAY / HYSTERESIS SETPOINT 2	digit 0
397			digit 4
398	199		digit 3
399			digit 2
400	200		digit 1
401			digit 0
402	201	DELAY / HYSTERESIS SETPOINT 3	digit 4
403			digit 3
404	202		digit 2
405			digit 1
406	203	DELAY / HYSTERESIS SETPOINT 4	digit 0
407			digit 4
408	204		digit 3
409			digit 2
410	205		digit 1
411			digit 0
412	206	ON-OFF SETPOINT 1	0=off, 1=on, 2=track, 3=rscom
413		ON-OFF SETPOINT 2	0=off, 1=on, 2=track, 3=rscom
414	207	ON-OFF SETPOINT 3	0=off, 1=on, 2=track, 3=rscom
415		ON-OFF SETPOINT 4	0=off, 1=on, 2=track, 3=rscom
416	208	COMP SETPOINT 1	0=net, 1=gross, 2=peak, 3=valley, 6=total
417		COMP SETPOINT 2	0=net, 1=gross, 2=peak, 3=valley, 4=max, 5=max filter, 6=total
418	209	COMP SETPOINT 3	0=net, 1=gross, 2=peak, 3=valley, 6=total
419		COMP SETPOINT 4	0=net, 1=gross, 2=peak, 3=valley, 6=total
420	210	HI-LO SETPOINT 1	0=hi, 1=lo
421		HI-LO SETPOINT 2	0=hi, 1=lo
422	211	HI-LO SETPOINT 3	0=hi, 1=lo
423		HI-LO SETPOINT 4	0=hi, 1=lo
424	212	DELAY-HYST SETPONT 1	0=delay, 1=hysteresis-1, 2=hysteresis-2
425		DELAY-HYST SETPONT 2	0=delay, 1=hysteresis-1, 2=hysteresis-2

426	213	DELAY-HYST SETPOINT 3	0=delay, 1=hysteresis-1, 2=hysteresis-2
427		DELAY-HYST SETPOINT 4	0=delay, 1=hysteresis-1, 2=hysteresis-2
428	214	LATCH SETPOINT 1	0=no, 1=yes
429		LATCH SETPOINT 2	0=no, 1=yes
430	215	LATCH SETPOINT 3	0=no, 1=yes
431		LATCH SETPOINT 4	0=no, 1=yes
432	216	BLINK SETPOINT 1	0=LED, 1=LED+blink
433		BLINK SETPOINT 2	0=LED, 1=LED+blink
434	217	BLINK SETPOINT 3	0=LED, 1=LED+blink
435		BLINK SETPOINT 4	0=LED, 1=LED+blink
436	218	TRACK AUTO	0=no, 1=yes
437		N° LINEARIZATION POINTS	2 to 30
438	219	N° READINGS SETPOINT MAX	digit 1
439			digit 0
440	220	ANALOG OUTPUT TYPE	0=Vdc, 1=Idc
441		ANALOG OUTPUT FILTER	0=off, 1=on
442	221	ANALOG OUTPUT	sign
443		HI DISPLAY	digit 4
444	222		digit 3
445			digit 2
446	223		digit 1
447			digit 0
448	224	ANALOG OUTPUT	sign
449		LO DISPLAY	digit 4
450	225		digit 3
451			digit 2
452	226		digit 1
453			digit 0
454	227	DIAMETER 1 (VOLUME)	digit 4
455			digit 3
456	228		digit 2
457			digit 1
458	229		digit 0
459		LENGTH 1 (VOLUME)	digit 4
460	230		digit 3

462	231		digit 1
463			digit 0
464	232	DIAMETER 2 (VOLUME)	digit 4
465			digit 3
466	233		digit 2
467			digit 1
468	234		digit 0
469			LENGTH 2 (VOLUME)
470	235		digit 3
471			digit 2
472	236		digit 1
473			digit 0
474	237	DIAMETER 3 (VOLUME)	digit 4
475			digit 3
476	238		digit 2
477			digit 1
478	239		digit 0
479			LENGTH 3 (VOLUME)
480	240		digit 3
481			digit 2
482	241		digit 1
483			digit 0
484	242	TANK'S SHAPE	0=no, 1=sphere, 2=cyinder, 3=cylinder+sphere, 4=silo
485		DECIMAL POINT (VOLUME)	0=88888, 1=8888.8, 2=888.88, 3=88.888, 4=8.8888
486	243	EXCITATION	0=24V, 1=10V
487		INPUT TYPE	0=process, 1=load cell, 2=Pt100, 3=thermocouple, 4=potentiometer
488	244	PROCESS TYPE	0=volts, 1=amperes
489		THERMOCOUPLE TYPE	0=TCJ, 1=TCK, 2=TCT, 3=TCR, 4=TCS, 5=TCE
490	245	PROCESS RANGE	0=1V/1mA, 1=10V/20mA
491		LOAD CELL RANGE	3=15mV, 2=30mV, 1=60mV, 0=300mV
492	246	TEMPERATURE SCALE	0=°C, 1=°F
493		TEMPERATURE RESOLUTION	0=0.1°, 1=1°
494	247	TEMPERATURE OFFSET	sign
495			digit 1
496	248		digit 0
497			DISPLAY DECIMAL POINT

498	249	FILTER P	0 to 9
499		FILTER E	0 to 9
500	250	READINGS AVERAGE	digit 2
501			digit 1
502	251		digit 0
503		BRIGHT	0=HI, 1=LO
504	252	LEFT ZEROS	0=no, 1=yes
505		RATE	0=16/s, 1=4/s, 2=1/s
506	253	ROUND	0=001, 1=002, 2=005, 3=010, 4=020, 5=050, 6=100
507		PRINT DATE AND TIME	0=off, 1=on
508	254	INTEGRATOR	0=no, 1=yes
509		TIME BASE	0=second, 1=minute, 2=hour, 3=day
510	255	INTEGRATOR FACTOR	digit 3
511			digit 2
512	256		digit 1
513			digit 0
514	257	FACTOR DECIMAL POINT	0=88888, 1=8888.8, 2=888.88, 3=88.888
515		TOTALIZER DECIMAL POINT	0=88888888, 1=8888888.8, 2=888888.88, 3=88888.888, 4=8888.8888, 5=888.88888, 6=88.888888, 7=8.8888888
516	258	LO-CUT	sign
517			digit 4
518	259		digit 3
519			digit 2
520	260		digit 1
521			digit 0
522	261	SECURITY CODE	digit 3
523			digit 2
524	262		digit 1
525			digit 0
526	263	SOFT LOCK 1	bit 0 =setpoint 1 bit 1 =setpoint 2 bit 2 =setpoint 3 bit 3 =setpoint 4

527		SOFT LOCK 2	bit 0 = input bit 1 = scaling+integrator+volume bit 2 = filters+display+round bit 3 = -
528	264	SOFT LOCK 3	bit 0 = analog output bit 1 = serial communication output bit 2 = logic inputs bit 3 = direct programming of setpoint values
529		SOFT LOCK 4	bit 0 = tare key function bit 1 = - bit 2 = - bit 3 = total lock
530	265	LOGIC FUNCTION CN2.1	0 to 36
531		LOGIC FUNCTION CN2.2	0 to 36
532	266	LOGIC FUNCTION CN2.3	0 to 36
533		LOGIC FUNCTION CN2.4	0 to 36
534	267	-	-
535		-	-
536	268	PROTOCOL	1=ASCII, 2=iso1745, 3=modbus
537		BAUD RATE	1=1200, 2=2400, 3=4800, 4=9600, 5=19200
538	269	ADDRESS TENS	0 to 9
539		ADDRESS UNITS	0 to 9
540	270	TRANSMISSION TO BETA-M	0=no, 1=yes
541		DELAY RS485	1=30ms, 2=60ms, 3=100ms, 4=300ms, 5=no delay

DINAMIC VARIABLES (READ ONLY)

MODBUS	Variable	Description	Format
276	Peak Value	Internal peak value	Long
278	Valley value	Internal valley value	Long
280	Tare value	Internal tare value	Long
282	Batch counter	Internal batch counter	Integer (1 word)
285	Totalizer	Internal totalizer counter	Float
287	Net value	Net value on display (with filters, round and hold)	Long
289	Gross value	Gross value on display (with filters, round and hold)	Long
291	Input signal value	Input signal value on display (with filters and hold)	Float
293	Setpoint1	Setpoint 1 value	Long
295	Setpoint2	Setpoint 2 value	Long
297	Setpoint3	Setpoint 3 value	Long
299	Setpoint4	Setpoint 4 value	Long
301	Batch	Batch Value on display (with filters and hold)	Integer (1 word)
302	Total	Total Value on display (with filters and hold)	Float
304	Peak	Peak Value on display (with filters and hold)	Long
306	Valley	Valley Value on display (with filters and hold)	Long
308	Net	Internal net value, without filter nor round	Long
310	Gross	Internal gross value, without filter nor round	Long
312	Input	Input signal value, no filter	Long
314	Net round	Net value with filters and round	Long
316	Gross round	Gross value with filters and round	Long
318	State of the setpoints and the logic inputs (0=deactivated, 1=activated)	bit 0 = setpoint 1 status bit 1 = setpoint 2 status bit 2 = setpoint 3 status bit 3 = setpoint 4 status bit 4 = logic input 1 status bit 5 = logic input 2 status bit 6 = logic input 4 status bit 7 = logic input 5 status	Byte



MODBUS	Variable	Description	Format
318	Options installed (0=not installed, 1=installed)	bit 0 = 2RE bit 1 = 4RE bit 2 = RS2 bit 3 = RS4 bit 4 = - bit 5 = BCD bit 6 = ANA bit 7 = -	Byte
319	Digits of the main display	digit 0 (LSB)	Byte
		digit 1	Byte
320		digit 2	Byte
		digit 3	Byte
321		digit 4	Byte
		digit 5 (MSB)	Byte
322		LED's -	Byte Byte
323	Digits of the auxiliary display	digit 0 (LSB)	Byte
		digit 1	Byte
324		digit 2	Byte
		digit 3	Byte
325		digit 4	Byte
		digit 5	Byte
326		digit 6 digit 7 (MSB)	Byte Byte
327	Version	units	Byte
		tens	Byte
328		hundreds	Byte
		'M'	Byte
329		'B'	Byte
	Sensor Break	0=OK, 1=Broken	Byte
330	Display overflow (internal)	0=no, 1=yes	Byte
	Input overflow	0=no, 1=yes	Byte
331	Display overflow	0=no, 1=yes	Byte
	Totalizer overflow	0=no, 1=yes	Byte

TARE MODE



tArE1

On tArE1 mode at one press of the  key, the instrument stores the value shown on display at this moment, if it is not on overflow, the TARE LED lights and from this moment the shown value is **net** value (the measured minus the stored). If the instrument already has a TARE and press once again the TARE key the value shown at this moment will be added to the previous TARE value, being the sum of both the resulting TARE. To clear TARE value, see page 59.

tArE2

In this mode, the TARE key has no effect when the instrument is in RUN. The TARE value will be programmed manually, nevertheless the way of working will be the same that in tArE1. The edit menu is accessed from the RUN mode, with pressing the ENTER key which will take us a –Pro- and pressing the TARE key more than 3 seconds will enable us with the keys  and  to enter the tare value in memory and pressing the ENTER key goes back to –run- and TARE LED will be on, not allowing more TAREs from the keyboard, having to reschedule to override it.

tArE3

In this mode we have to program the “**net**” value, from RUN mode press more than 3 seconds the  and according the diagram on page 98, program the net value (usually indicated on the container). Action TARE, as in the tArE2 case will not take effect until a press of  key, being the instrument in RUN mode, also the TARE LED will light. The value stored now on TARE is the difference between the measured value at the moment of TARE was made and the “**net**” value programmed. Being the display shown, the difference between the measured and calculated tare. You will need to enter the programming menu and go through “CndSP” > “ModtA” to delete the TARE, the  key is inactive until reprogrammed.

Example:

A process using the liquid in a container that is known as the manufacturer's gross weight 100 Kg and 75 Kg net. It is used in the process of weighing a load cell connected to an instrument and need to know the net weight of liquid at every moment of the process. Selecting this mode of tare, net value would be introduced by editing. When the instrument is measuring the weight of the drum, now completely filled with liquid, which would be 100 kg, tare the instrument and the measure now shows 75 kg, and measuring from this value to 0 during the emptying of it.

Programming:

If have selected input Process or Potentiometer, on the menu 20 "CndSP" after submenu 27 "-Vol-" and with another push of  key you get the submenu **ModTA**.

If have selected input "Load Cell" on the menu 20 "CndSP" after the submenu 26 and pushing  key you get the submenu **ModTA**.







If selected Process or Potentiometer



If selected Load Cell



PROGRAMMING NET VALUE IN TARE MODE 3

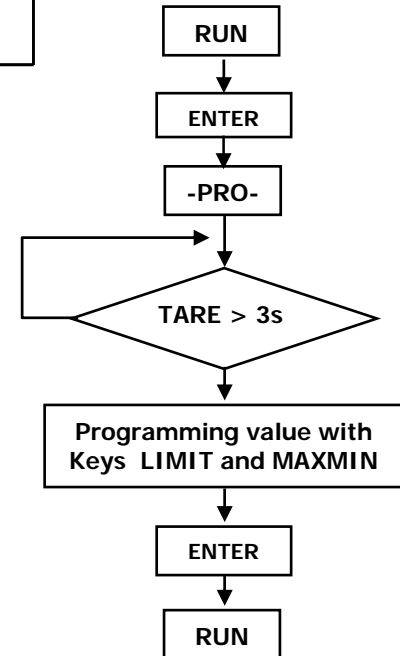

To edit the net value, being the instrument in RUN mode, press the  key to get the indication -Pro- then press the  key more than 3 seconds, showing the display the last TARE value programmed and the most left red digit blinking, with  key and  key program the **NET** value, usually indicated on the container, validate with  key and the instrument goes back to normal working, **at this moment and with the container over the platform should be pressed  key**, passing the instrument to show the programmed net weight and activating the TARE led, from this moment on the TARE key has no effect on the weight indication.



SENSOR BREAK

This function allows detecting any broken wire that connect the sensor "Load Cell" to the instrument. The analysis to detect the broken wires is done every 1,5 seconds and the response of Relays and ANA options (if used) will be the same if it were a overflow (**oVFLo**) situation, input signal greater than allowed.

NOTE: This detection system works only if the sensor is supplied with the excitation voltage from the instrument.

If the input "Load Cell" has been programmed, on the menu 20 "CndSP" after the submenu 28 with an other press of  key we got the submenu 29 **-Sbr- Sensor Break** and pressing  key is possible to select **-on-** to activate or **-oFF-** to deactivate.

If selected Load Cell



FAIL SAFE

Function that allows detecting the power supply fault or an instrument fault and in this way can be informed the PLC or another general system of supervision using the relay option programmed in this way.

This function can be programmed on any of the activated relay, in the submenu 31, 32, 33, 34 after the programming parameter "**-Hi-Lo-**" will show "**-no nc-**" (no=normally open), (nc=normally closed)

-nc- is the FAIL SAFE mode

SETPOINT VALUE

888888

HI-LO

HI

Lo

NO-NC when selected NC works in **FAIL SAFE** mode

no

nc

DLY-HISTERESIS

dLY

HYS1

HYS2

LATCH

no

YES

BLINK

no

YES

r.o.C. Function (rate of Change)

The function **r.o.C** is useful to detect the changing speed of display value, depending on programmed setpoint polarity we detect the increasing or decreasing.

In mode **r.o.C.**, if the setpoint values is, for example = 1000, that means that the alarm will be activated when the display value increase more than 1000 points per second.

If the setpoint value were, for example = -1000, the alarm would be activated when the display value decrease with a speed greater than 1000 points per second.

The **r.o.C.** alarms have the same programmable options than the rest of alarms, namely, you can choose the mode of action, HI-LO, NO-NC, Latch, delay-histeresys, LED-LED+blink. The only difference is if delay is selected, on the **r.o.C.** alarms not apply to the activation and deactivation, but only to the deactivation of the alarm. This function is applicable separately to activate each of setpoints.

Programming:

If has been programmed input: Process, Potentiometer, Load Cell in the submenu 31 CoMP after the “-VAL-” pressing the  key gets the function **r.o.C.**, or in the submenu 32 gets after the MaxF or total (if activated).

If has been programmed input : Temp, in the submenus 31, 32, 33, 34 gets after the -VAL-

Note: The **ovflo** situation (be by sensor break, or excess of input signal, or incorrect programming) leads to the relays to the rest situation that corresponds according to the program established.

PROCESS, POTENTIOMETER and LOAD CELL

nEt	Gros	PEAK	VAL	MAX(*)	MAXF(*)	total(**)	roC
-----	------	------	-----	--------	---------	-----------	-----

(*) Only Setpoint 2

(**) Only if the totalized or integrator variable exist

THERMOCOUPLE and Pt100

nEt	PEAK	VAL	roC
-----	------	-----	-----

doSE

If has been programmed input "Load Cell, Potentiometer or Process", **only in the submenu 31** is possible to select the function "doSE"

WAY of WORKING of SETPOINT1 in MODE "doSE"

When the function "doSE" is selected on the setpoint 1 menu, can not choose the comparison value, since it will be on the net value of the display. Nor can choose HI or LO mode as this will depend on whether the setpoint is positive (HI) or negative (LO) and the numerical value of setpoint will have to be mandatory to program on the direct programming of setpoint values routine (keys ENTER and LIMIT).

When exit from menu 31 with "doSE" option selected, the setpoint is locked and it doesn't work.

To start working have to enter on direct programming routine and gives it a value.

When you press ENTER, the set value is added to the net internal value of display (if positive, "and is automatically HI-mode) or subtracted (if negative," and is put in LO-mode).

At this time, enables the operation of the setpoint 1.

Each time the display increases (HI) or decrease (LO) in a number of points equal to the programmed setpoint 1 value will activate the output relay.

Likewise, if the logical function n° 30 has been programmed, the setpoint value will be added to the totalizer and increase the batch number in one unit.

If you also enable pin which is scheduled this logic function, two parameters are displayed in the main and secondary displays.

Activation of the relay output last time has been programmed on parameter "dLY" Setpoint1 menu or, if selected mode "LATCH", will be permanently activated until a reset is made of setpoints LATCH (logical function No. 25).

(*) It's not possible to program "trAC" if on the menu 31 has been programmed "doSE"

MENU 31

oFF	on	CoM	doSE
-----	----	-----	------

MENU 32

oFF	on	CoM	trAC(*)
-----	----	-----	---------

MENU 34

oFF	on	CoM	trAC
-----	----	-----	------

oFF	on	CoM	trAC(*)
-----	----	-----	---------

MENU 34

oFF	on	CoM	trAC
-----	----	-----	------



INSTRUCTIONS FOR THE RECYCLING

This electronic instrument is covered by the **2002/96/CE** European Directive so, it is properly marked with the crossed-out wheeled bin symbol that makes reference to the selective collection for electrical and electronic equipment which indicates that at the end of its lifetime, the final user cannot dispose of it as unsorted municipal waste.

In order to protect the environment and in agreement with the European legislation regarding waste of electrical and electronic equipments from products put on the market after 13 August 2005, the user can give it back, without any cost, to the place where it was acquired to proceed to its controlled treatment and recycling.

DISEÑO

Polígono

C/ Xaroi 8 c

08915 BADALONA-SPAIN

Tel : +34 - 93 339 47 58

Fax : +34 - 93 490 31 45

E-mail : dtl@ditel.es

www.ditel.es