



DITEL: PRODUCTS: DIGITAL STARS: 721SX



[Print this page](#)

DESCRIPTION

Model 721S panel indicators for process control provide sizeable zero and span capabilities for direct readout in engineering units.

Their input option is jumper-configurable for the most popular current process signals such as 0-1mA, 0-5mA, 0-20mA, 4-20mA or user-selected ranges.

Fully configured at fabrication, it is possible to change later the scale and the decimal point location by means of plug-in jumpers and readjust zero and span by two potentiometers which are accessible behind lens.

These indicators are available in 700 or 7000 series. The latter provides one analog setpoint that can be made to operate with two modes of ON/OFF commutation and switching hysteresis.

SELECTION GUIDE

721	S	X	Y	0	9
PRESET/RELAY					
NO SETPOINT (series 700)	0				
1 SETPOINT (Series 7000)	4				
INPUT TYPE					
0-1mADC		2			
0-5mADC		3			
0-20mADC		4			
4-20mADC		5			
UPON REQUEST		9			
SUPPLY POWER					
115V 50/60Hz			1		
230V 50/60Hz			2		
12V DC ISOLATED			4		
24V 50/60Hz			7		
24V DC ISOLATED			8		
SILKSCREENED UNIT					

ORDERING EXAMPLE

7214 5209 E50: Process ammeter series 700 Supply power: 230V AC (50/60Hz)
Input type: 4-20mA DC. Unit: bar 1 potent. adjustable analog setpoint

SPECIFICATIONS

INPUT SIGNAL

Configuration

differential
asymmetrical

Input range

selectable by
jumpers

Input impedance

Z (IN)

INPUT Z (IN)	0-1mA 1000ohm	0-5mA 200ohm	0-20mA 50ohm	4-20mA 50ohm

Common mode max. voltage (signal/power)

- AC voltage : 1000V DC or 1500V ACpp

- DC voltage : \pm 400V DC

POWER

Supply voltages

- AC (50/60Hz) :

24, 115, 230V AC

- DC (isolated) :

12, 24V DC

Maximum isolation

1000V DC or 1500V ACpp

Power consumption

2.5W nominal

ACCURACY

Resolution

0.05% F.S.

Maximum error

0.1% F.S. \pm 1 digit

DISPLAY

Type

red LED (0.4") 10mm. high

Display range

potentiometer-adjustable

Decimal point

selectable by jumper

A/D conversion technique

dual slope

Reading rate

3 per second

ENVIRONMENTAL

Operating temperature

0° to 50°C

Storage temperature

-25° to +85°C

Relative humidity

max. 95% (non condensing)

Weight

310g

Dimensions

72x36x110mm. (s/DIN 43700)

Panel cutout

68x33mm. (s/DIN 43700)

Case material

94 V-0 UL-rated polycarbonate

OPTIONS (SERIE 7000)

1 front panel screwdriver-adjustable setpoint with two modes of ON/OFF control and switching hysteresis. SPDT relay (8A @ 250VAC or 8A @ 40VDC).

DIMENSIONS (mm)

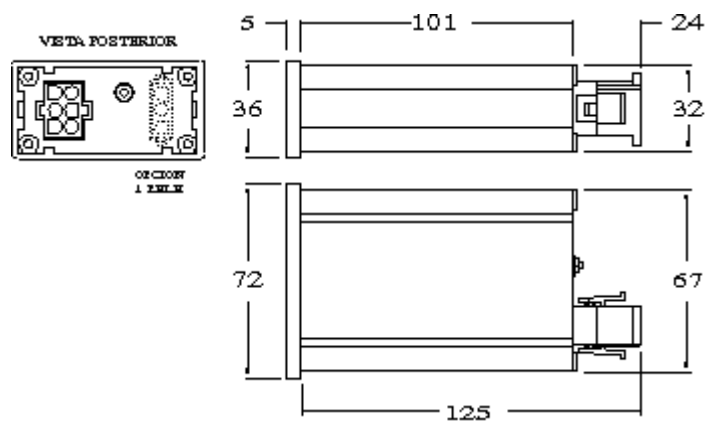

SIGNAL AND POWER CONNECTION

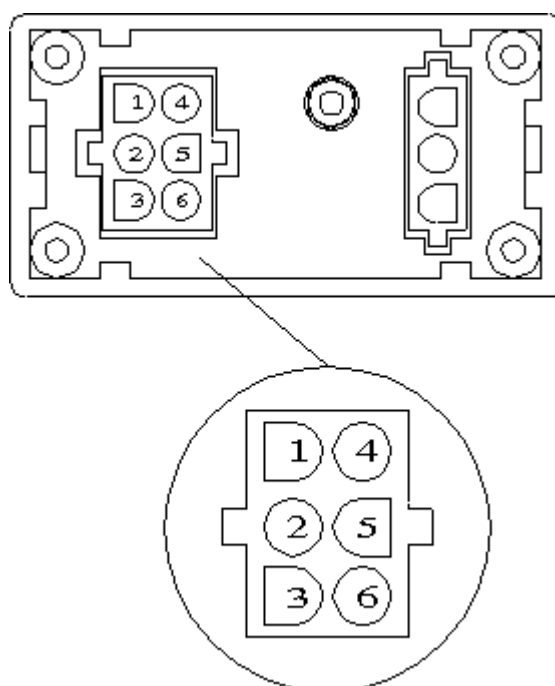

Input signal
 PIN 1 Spare
 PIN 2 Input signal (+)
 PIN 3 Input signal (-)

AC power supply
 PIN 4 AC HI
 PIN 5 Spare
 PIN 6 AC LO (neutral)

DC power supply
 PIN 4 DC positive (+)
 PIN 5 Spare
 PIN 6 DC negative (-)

SCALING

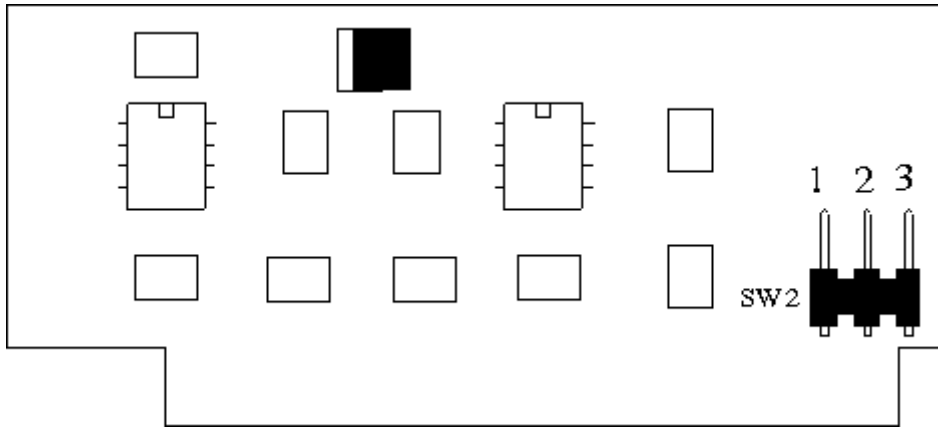

To obtain a specific display range corresponding to a specific signal range, adjust the zero potentiometer to get the display reading at minimum input and the span potentiometer until the display reads the desired value for maximum input. Repeat these operations until the proper readout is obtained at both extremes. Place finally the decimal point.

If the display readout is to go down as the input signal increases (negative gain), place the jumper 2-3 of SW2, for positive gain, place jumper 1-2.

MOUNTING

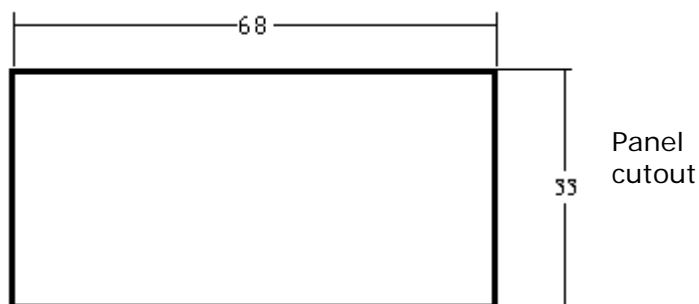

Min. thickness : 0.8mm
Max. thickness : 10mm

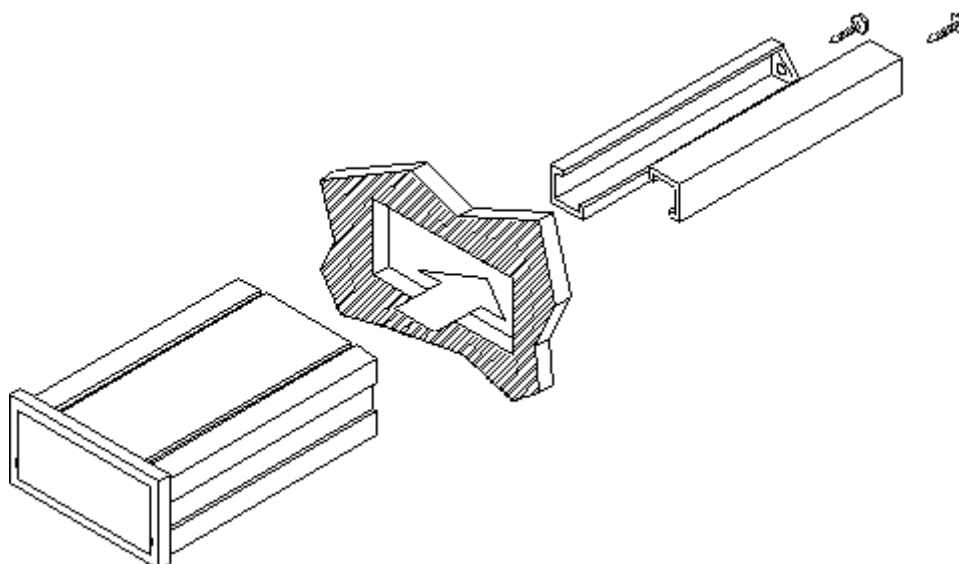

INPUT CONFIGURATION

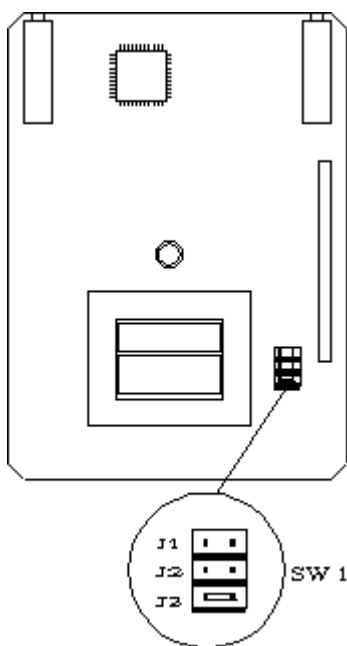

Input	Jumpers
0-1mA	J3
0-5mA	J2
0-20mA	J1
4-20mA	J1

To configure the meter for the desired input, perform the jumper wiring as indicated above.

SETUP AND CALIBRATION

The lens of the meter are

removable from the front to allow access to zero, span adjustment and to decimal point location. Plug in proper jumper to set the decimal point in the desired position according to the table.

Jumper	Display
A	1.999
B	19.99
C	199.9
none	1999

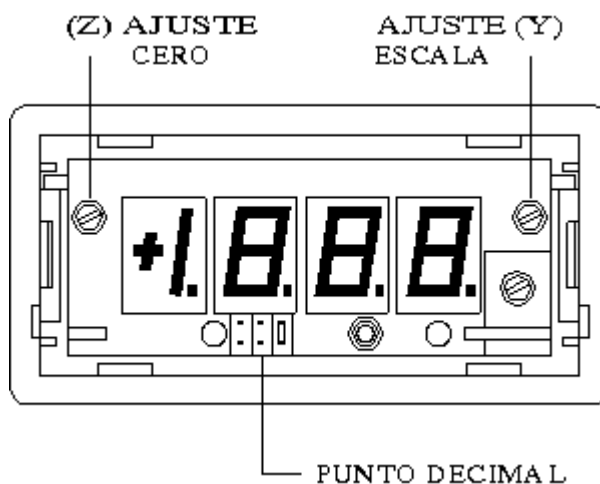
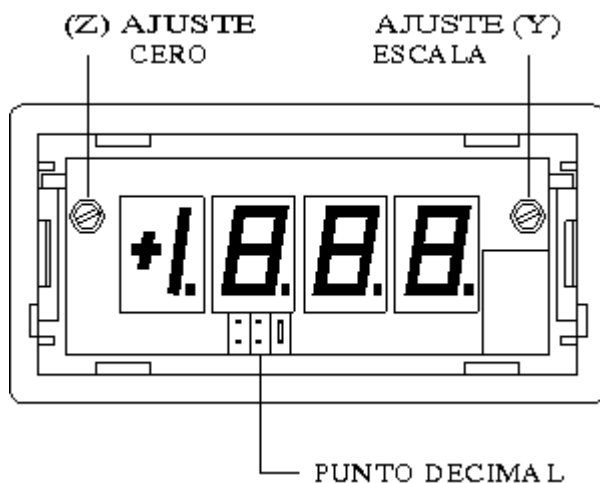

Warranty:

Press the icon to see it.



[Change language](#) | [Back to the menu](#)

