

**OPERATION MANUAL  
FOR DISPLAYS SERIES  
DN-109AP, DN-119AP,  
DN-129AP AND DN-189AP**

## Index

|   |     |
|---|-----|
| 1. INTRODUCTION .....   | 1-1 |
| 2. GENERAL CHARACTERISTICS. ....  | 2-1 |
| 2.1. Electrical characteristics .....   | 2-1 |
| 2.1.1. Electrical characteristics of the DN-109 displays. ....                | 2-1 |
| 2.1.2. Electrical characteristics of the DN-119 displays. ....                | 2-2 |
| 2.1.3. Electrical characteristics of the DN-189 displays. ....                | 2-3 |
| 2.1.4. Electrical characteristics of the DN-129 displays. ....                | 2-4 |
| 2.2. Display weight and power consumption. ....                               | 2-5 |
| 2.2.1. DN-109 weight and power consumption. ....                              | 2-5 |
| 2.2.2. DN-119 weight and power consumption. ....                              | 2-5 |
| 2.2.3. DN-189 weight and power consumption. ....                              | 2-5 |
| 2.2.4. DN-129 weight and power consumption. ....                              | 2-5 |
| 2.3. Dimensions and mounting of the Displays .....                            | 2-6 |
| 2.3.1. Dimensions and mounting of the DN-109 and DN-119 .....                 | 2-6 |
| 2.3.2. Dimensions and mounting of the DN-129 and DN-189 .....                 | 2-7 |
| 3. INSTALLATION .....   | 3-1 |
| 3.1. Power supply. ....   | 3-1 |
| 3.2. Position of the buttons and connectors.....                              | 3-2 |
| 3.3. Analog inputs connection.....  | 3-2 |
| 3.3.1. Voltage input. 4 wire connection. External excitation.....             | 3-2 |
| 3.3.2. Voltage input. 3 wire connection. External excitation.....             | 3-3 |
| 3.3.3. Voltage input. 4 wire connection. Excitation supplied by display ..... | 3-3 |
| 3.3.4. Voltage input. 3 wire connection. Excitation supplied by display.....  | 3-3 |
| 3.3.5. Current input. 4 wire connection. External excitation.....             | 3-4 |
| 3.3.6. Current input. 3 wire connection. External excitation.....             | 3-4 |
| 3.3.7. Current input. 2 wire connection. External excitation.....             | 3-4 |
| 3.3.8. Current input. 4 wire connection. Excitation supplied by display.....  | 3-5 |
| 3.3.9. Current input. 3 wire connection. Excitation supplied by display.....  | 3-5 |
| 3.3.10. Current input. 4 wire connection. Excitation supplied by display..... | 3-5 |
| 3.4. Connection of the remote keys.....                                       | 3-6 |
| 4. OPERATION.....   | 4-1 |
| 4.1. Initial reset.....   | 4-1 |
| 4.2. Programming parameters.....  | 4-1 |
| 4.2.1. Enter to modify parameters.....  | 4-1 |
| 4.2.2. Configuration of the analog inputs .....                               | 4-2 |

|  |      |
|--|------|
| 4.2.3. Error displaying .....                              | 4-3  |
| 4.2.4. Automatic decimal point. ....                       | 4-3  |
| 4.2.5. Function of each parameter. ....                    | 4-4  |
| 4.3. Taring the display.....                               | 4-7  |
| 4.4. Alarms configuration (flash, colour and relays) ..... | 4-8  |
| 4.4.1. Parameter map of the alarms.....                    | 4-9  |
| 4.4.2. Parameters for defining the alarm 1 .....           | 4-12 |
| 4.4.3. Parameter for defining the alarm 2.....             | 4-13 |
| 4.4.4. Parameters to define the colour. ....               | 4-14 |
| 4.4.5. Characteristics of the relay output option.....     | 4-14 |
| 4.4.6. Wiring the relay output .....                       | 4-14 |
| 4.5. Ethernet option.....                                  | 4-15 |
| 4.5.1. The first connection .....                          | 4-15 |
| 4.5.2. User interface .....                                | 4-18 |
| 4.5.3. Ethernet parameter configuration .....              | 4-22 |
| 4.5.4. Communication with commands through Ethernet .....  | 4-23 |

## 1. INTRODUCTION

The numerical displays for series **DN-109AP, DN-119AP, DN-129AP and DN-189AP (DN-1\_9AP)**, are industrial displays with analog input for the control processes. All the models are manufactured in versions of 3, 4 or 5 digits, with one or two display sides.

The large digit display size **DN-109AP of 57mm, DN-119AP of 100mm, DN-129AP of 250mm and DN-189 of 180mm** with a legible distance from 30m to 120m, is one of the main characteristics.

The colour option, only available in some models, lets you select the digit colour between red, green and yellow.

All the equipment is provided completely calibrated, with the data stored in non-volatile memory, eliminating the use of trimming potentiometers.

## 2. GENERAL CHARACTERISTICS.

### 2.1. Electrical characteristics

#### 2.1.1. Electrical characteristics of the DN-109 displays.

|  |  |
|--|--|
| <b>Supply Voltage</b> .....                        | 88 to 264 VAC 47 to 63Hz or 19 to 36VDC:               |
| <b>Consumption</b> .....                           | See "Display weight and power consumption."            |
| <b>Display</b> .....                               | 7 segments, 57mm high + decimal point.                 |
| .....  | Red Led colour. Viewing distance: max 30 meters.       |
| <b>Text (LED)</b> .....                            | Formed by LEDs of 5mm diameter, 50mm character height. |
| .....  |  |
| <b>Text (Vinyl)</b> .....                          | White vinyl. 50mm character height.                    |
| <b>Parameter memory</b> .....                      | Eeprom.  |
| <b>Communication</b> .....                         | RS-232 and RS-485. Option RS-422.                      |
| <b>Communication Protocols</b> .....               | All included   |
| <b>Environmental Conditions</b> .....              | Operation Temperature: -20 to 60°C.                    |
| .....  | Storage temperature: -30°C to 70°C.                    |
| .....  | Humidity: 5-95% RH non condensing.                     |
| .....  | Maximum environmental illumination: 1000 lux.          |
| .....  | Sealing: IP41 or IP65.                                 |
| <b>Input signal</b>                                |  |
| <b>Configuration</b> .....                         | Differential asymmetrical.                             |
| <b>Voltage input</b>                               |  |
| <b>Range</b> .....                                 | ±10V DC  |
| <b>Resolution</b> .....                            | 0.5 mV   |
| <b>Input impedance</b> .....                       | 1 MOhm   |
| <b>Current input</b>                               |  |
| <b>Range</b> .....                                 | ±20mA DC   |
| <b>Resolution</b> .....                            | 5 µA   |
| <b>Input impedance</b> .....                       | 12.1 Ohm   |
| <b>Output excitation</b> .....                     | 24V DC – 100mA   |
| <b>Accuracy to 22° ±5°C</b>                        |  |
| <b>Maximum error</b> .....                         | ±(0,1% of reading + 3 digits)                          |
| <b>Temperature coefficient</b> .....               | 100ppm/°C  |
| <b>Warm up time</b> .....                          | 5 minutes  |
| <b>Conversion method</b>                           |  |
| <b>Technique</b> .....                             | Sigma-Delta  |
| <b>Resolution</b> .....                            | 16 bits  |
| <b>Rate</b> .....                                  | 25 samples/s   |
| <b>Display</b>                                     |  |
| <b>Resolution 3 digits displays</b> .....          | -199 / 999   |
| <b>Resolution 4 digits displays</b> .....          | -1999 / 9999   |
| <b>Resolution 5 digits displays</b> .....          | -19999 / 99999   |
| <b>Over-range 3 digits displays</b> .....          | -OE/ OuE   |
| <b>Over-range 4 and 5 digits displays</b> .....    | -OuE / OuE   |
| <b>Parameter error. IP1 &gt; IP2</b> .....         | E0   |
| <b>Non input signal or polarity inverted</b> ..... | E2   |
| <b>Over-range input signal</b> .....               | E3   |

### 2.1.2. Electrical characteristics of the DN-119 displays.

|  |  |
|--|--|
| <b>Supply Voltage</b> .....                        | 88 to 264 VAC 47 to 63Hz or 19 to 36VDC:               |
| <b>Consumption</b> .....                           | See "Display weight and power consumption."            |
| <b>Display</b> .....                               | 7 segments, 100mm high + decimal point.                |
| .....  | Red Led colour. Viewing distance: max 50 meters.       |
| <b>Text (LED)</b> .....                            | Formed by LEDs of 5mm diameter, 65mm character height. |
| .....  | height.  |
| <b>Text (Vinyl)</b> .....                          | White vinyl. 65mm character height.                    |
| <b>Parameter memory</b> .....                      | Eeprom.  |
| <b>Communication</b> .....                         | RS-232 and RS-485. Option RS-422.                      |
| <b>Communication Protocols</b> .....               | All included.  |
| <b>Environmental Conditions</b> .....              | Operation Temperature: -20 to 60°C.                    |
| .....  | Storage temperature: -30°C to 70°C.                    |
| .....  | Humidity: 5-95% RH non condensing.                     |
| .....  | Maximum environmental illumination: 1000 lux.          |
| .....  | Sealing: IP41 or IP65.                                 |
| <b>Input signal</b>                                |  |
| <b>Configuration</b> .....                         | Differential asymmetrical.                             |
| <b>Voltage input</b>                               |  |
| <b>Range</b> .....                                 | ±10V DC  |
| <b>Resolution</b> .....                            | 0.5 mV   |
| <b>Input impedance</b> .....                       | 1 MOhm   |
| <b>Current input</b>                               |  |
| <b>Range</b> .....                                 | ±20mA DC   |
| <b>Resolution</b> .....                            | 5 µA   |
| <b>Input impedance</b> .....                       | 12.1 Ohm   |
| <b>Output excitation</b> .....                     | 24V DC – 100mA   |
| <b>Accuracy to 22° ±5°C</b>                        |  |
| <b>Maximum error</b> .....                         | ±(0,1% of reading + 3 digits)                          |
| <b>Temperature coefficient</b> .....               | 100ppm/°C  |
| <b>Warm up time</b> .....                          | 5 minutes  |
| <b>Conversion method</b>                           |  |
| <b>Technique</b> .....                             | Sigma-Delta  |
| <b>Resolution</b> .....                            | 16 bits  |
| <b>Rate</b> .....                                  | 25 samples/s   |
| <b>Display</b>                                     |  |
| <b>Resolution 3 digits displays</b> .....          | -199 / 999   |
| <b>Resolution 4 digits displays</b> .....          | -1999 / 9999   |
| <b>Resolution 5 digits displays</b> .....          | -19999 / 99999   |
| <b>Over-range 3 digits displays</b> .....          | -OE/ OuE   |
| <b>Over-range 4 and 5 digits displays</b> .....    | -OuE / OuE   |
| <b>Parameter error. IP1 &gt; IP2</b> .....         | E0   |
| <b>Non input signal or polarity inverted</b> ..... | E2   |
| <b>Over-range input signal</b> .....               | E3   |

### 2.1.3. Electrical characteristics of the DN-189 displays.

|  |  |
|--|--|
| <b>Supply Voltage</b> .....                        | 88 to 264 VAC 47 to 63Hz or 19 to 36VDC:         |
| <b>Consumption</b> .....                           | See "Display weight and power consumption."      |
| <b>Display</b> .....                               | 7 segments, 180mm high + decimal point.          |
| .....  | Red Led colour. Viewing distance: max 90 meters. |
| <b>Text (Vinyl)</b> .....                          | White vinyl.                                     |
| <b>Parameter memory</b> .....                      | Eeprom.  |
| <b>Communication</b> .....                         | RS-232 and RS-485. Option RS-422.                |
| <b>Communication Protocols</b> .....               | All included.                                    |
| <b>Environmental Conditions</b> .....              | Operation Temperature: -20 to 60°C.              |
| .....  | Storage temperature: -30°C to 70°C.              |
| .....  | Humidity: 5-95% RH non condensing.               |
| .....  | Maximum environmental illumination: 1000 lux.    |
| .....  | Sealing: IP41 or IP65.                           |
| <b>Input signal</b>                                |  |
| <b>Configuration</b> .....                         | Differential asymmetrical.                       |
| <b>Voltage input</b>                               |  |
| <b>Range</b> .....                                 | ±10V DC  |
| <b>Resolution</b> .....                            | 0.5 mV   |
| <b>Input impedance</b> .....                       | 1 MOhm   |
| <b>Current input</b>                               |  |
| <b>Range</b> .....                                 | ±20mA DC   |
| <b>Resolution</b> .....                            | 5 µA   |
| <b>Input impedance</b> .....                       | 12.1 Ohm   |
| <b>Output excitation</b> .....                     | 24V DC – 100mA                                   |
| <b>Accuracy to 22° ±5°C</b>                        |  |
| <b>Maximum error</b> .....                         | ±(0,1% of reading + 3 digits)                    |
| <b>Temperature coefficient</b> .....               | 100ppm/°C  |
| <b>Warm up time</b> .....                          | 5 minutes  |
| <b>Conversion method</b>                           |  |
| <b>Technique</b> .....                             | Sigma-Delta                                      |
| <b>Resolution</b> .....                            | 16 bits  |
| <b>Rate</b> .....                                  | 25 samples/s                                     |
| <b>Display</b>                                     |  |
| <b>Resolution 3 digits displays</b> .....          | -199 / 999                                       |
| <b>Resolution 4 digits displays</b> .....          | -1999 / 9999                                     |
| <b>Resolution 5 digits displays</b> .....          | -19999 / 99999                                   |
| <b>Over-range 3 digits displays</b> .....          | -OE/ OuE   |
| <b>Over-range 4 and 5 digits displays</b> .....    | -OuE / OuE                                       |
| <b>Parameter error. IP1 &gt; IP2</b> .....         | E0   |
| <b>Non input signal or polarity inverted</b> ..... | E2   |
| <b>Over-range input signal</b> .....               | E3   |

### 2.1.4. Electrical characteristics of the DN-129 displays.

|  |   |
|--|---|
| <b>Supply Voltage</b> .....                        | 88 to 264 VAC 47 to 63Hz or 19 to 36VDC:          |
| <b>Consumption</b> .....                           | See "Display weight and power consumption."       |
| <b>Display</b> .....                               | 7 segments, 250mm high + decimal point.           |
| .....  | Red Led colour. Viewing distance: max 120 meters. |
| <b>Text (Vinyl)</b> .....                          | White vinyl.                                      |
| <b>Parameter memory</b> .....                      | Eeprom.   |
| <b>Communication</b> .....                         | RS-232 and RS-485. Option RS-422.                 |
| <b>Communication Protocols</b> .....               | All included.                                     |
| <b>Environmental Conditions</b> .....              | Operation Temperature: -20 to 60°C.               |
| .....  | Storage temperature: -30°C to 70°C.               |
| .....  | Humidity: 5-95% RH non condensing.                |
| .....  | Maximum environmental illumination: 1000 lux.     |
| .....  | Sealing: IP41 or IP54.                            |
| <b>Input signal</b>                                |   |
| <b>Configuration</b> .....                         | Differential asymmetrical.                        |
| <b>Voltage input</b>                               |   |
| <b>Range</b> .....                                 | ±10V DC   |
| <b>Resolution</b> .....                            | 0.5 mV  |
| <b>Input impedance</b> .....                       | 1 MOhm  |
| <b>Current input</b>                               |   |
| <b>Range</b> .....                                 | ±20mA DC  |
| <b>Resolution</b> .....                            | 5 µA  |
| <b>Input impedance</b> .....                       | 12.1 Ohm  |
| <b>Output excitation</b> .....                     | 24V DC – 100mA                                    |
| <b>Accuracy to 22° ±5°C</b>                        |   |
| <b>Maximum error</b> .....                         | ±(0,1% of reading + 3 digits)                     |
| <b>Temperature coefficient</b> .....               | 100ppm/°C   |
| <b>Warm up time</b> .....                          | 5 minutes   |
| <b>Conversion method</b>                           |   |
| <b>Technique</b> .....                             | Sigma-Delta                                       |
| <b>Resolution</b> .....                            | 16 bits   |
| <b>Rate</b> .....                                  | 25 samples/s                                      |
| <b>Display</b>                                     |   |
| <b>Resolution 3 digits displays</b> .....          | -199 / 999  |
| <b>Resolution 4 digits displays</b> .....          | -1999 / 9999                                      |
| <b>Resolution 5 digits displays</b> .....          | -19999 / 99999                                    |
| <b>Over-range 3 digits displays</b> .....          | -OE/ OuE  |
| <b>Over-range 4 and 5 digits displays</b> .....    | -OuE / OuE  |
| <b>Parameter error. IP1 &gt; IP2</b> .....         | E0  |
| <b>Non input signal or polarity inverted</b> ..... | E2  |
| <b>Over-range input signal</b> .....               | E3  |



## 2.2. Display weight and power consumption.

### 2.2.1. DN-109 weight and power consumption.

| Reference | Display Weight (kg) | Power (W) | Reference    | Display weight (kg) | Power (W) | Reference    | Display weight (kg) | Power (W) |
|-----------|---------------------|-----------|--------------|---------------------|-----------|--------------|---------------------|-----------|
| DN-109/3S | 3,0                 | 5,9       | DN-109/3S+TL | 3,0                 | 7,9       | DN-109/3S+TV | 3,0                 | 5,9       |
| DN-109/3D | 3,0                 | 10        | DN-109/3D+TL | 3,0                 | 11,7      | DN-109/3D+TV | 3,0                 | 10        |
| DN-109/4S | 3,0                 | 7,54      | DN-109/4S+TL | 3,5                 | 9,6       | DN-109/4S+TV | 3,5                 | 7,54      |
| DN-109/4D | 3,5                 | 14,44     | DN-109/4D+TL | 3,5                 | 15,1      | DN-109/4D+TV | 3,5                 | 14,44     |
| DN-109/5S | 3,0                 | 9,2       | DN-109/5S+TL | 3,5                 | 11,2      | DN-109/5S+TV | 3,5                 | 9,2       |
| DN-109/5D | 3,5                 | 18        | DN-109/5D+TL | 4,5                 | 21,7      | DN-109/5D+TV | 4,0                 | 18        |

### 2.2.2. DN-119 weight and power consumption.

| Reference | Display Weight (kg) | Power (W) | Reference    | Display weight (kg) | Power (W) | Reference    | Display weight (kg) | Power (W) |
|-----------|---------------------|-----------|--------------|---------------------|-----------|--------------|---------------------|-----------|
| DN-119/3S | 4,0                 | 10,8      | DN-119/3S+TL | 4,5                 | 13,4      | DN-119/3S+TV | 4,5                 | 10,8      |
| DN-119/3D | 4,0                 | 18        | DN-119/3D+TL | 5,0                 | 20        | DN-119/3D+TV | 5,0                 | 18        |
| DN-119/4S | 4,5                 | 14        | DN-119/4S+TL | 5,5                 | 16,6      | DN-119/4S+TV | 5,5                 | 14        |
| DN-119/4D | 5,0                 | 26,6      | DN-119/4D+TL | 5,5                 | 31,9      | DN-119/4D+TV | 5,5                 | 26,6      |
| DN-119/5S | 5,0                 | 17        | DN-119/5S+TL | 5,5                 | 19,7      | DN-119/5S+TV | 5,5                 | 17        |
| DN-119/5D | 5,5                 | 32,9      | DN-119/5D+TL | 6,0                 | 38,1      | DN-119/5D+TV | 6,0                 | 32,9      |

### 2.2.3. DN-189 weight and power consumption.

| Reference | Display Weight (kg) | Power (W) | Reference    | Display weight (kg) | Power (W) |
|-----------|---------------------|-----------|--------------|---------------------|-----------|
| DN-189/3S | 5,0                 | 19,4      | DN-189/3S+TV | 6,5                 | 19,4      |
| DN-189/3D | 6,0                 | 38,2      | DN-189/3D+TV | 8,0                 | 38,2      |
| DN-189/4S | 6,0                 | 25,7      | DN-189/4S+TV | 7,5                 | 25,7      |
| DN-189/4D | 7,5                 | 50,8      | DN-189/4D+TV | 9,0                 | 50,8      |
| DN-189/5S | 7,0                 | 31,8      | DN-189/5S+TV | 9,0                 | 31,8      |
| DN-189/5D | 8,5                 | 63,2      | DN-189/5D+TV | 10,5                | 63,2      |

### 2.2.4. DN-129 weight and power consumption.

| Reference | Display Weight (kg) | Power (W) | Reference    | Display weight (kg) | Power (W) |
|-----------|---------------------|-----------|--------------|---------------------|-----------|
| DN-129/3S | 8,5                 | 20        | DN-129/3S+TV | 11,5                | 20        |
| DN-129/3D | 10,5                | 40        | DN-129/3D+TV | 13,5                | 40        |
| DN-129/4S | 10,5                | 26        | DN-129/4S+TV | 13,0                | 26        |
| DN-129/4D | 13,0                | 52        | DN-129/4D+TV | 16,0                | 52        |
| DN-129/5S | 12,0                | 32        | DN-129/5S+TV | 15,0                | 32        |
| DN-129/5D | 15,5                | 64        | DN-129/5D+TV | 18,5                | 64        |

## 2.3. Dimensions and mounting of the Displays

### 2.3.1. Dimensions and mounting of the DN-109 and DN-119

| Reference | A   | B   | Reference   | A   | B   |
|-----------|-----|-----|-------------|-----|-----|
| DN-109/3S | 288 | 122 | DN-109/3S+T | 288 | 122 |
| DN-109/4S | 288 | 122 | DN-109/4S+T | 336 | 122 |
| DN-109/5S | 288 | 122 | DN-109/5S+T | 382 | 122 |
| DN-119/3S | 324 | 177 | DN-119/3S+T | 504 | 177 |
| DN-119/4S | 414 | 177 | DN-119/4S+T | 594 | 177 |
| DN-119/5S | 504 | 177 | DN-119/5S+T | 684 | 177 |

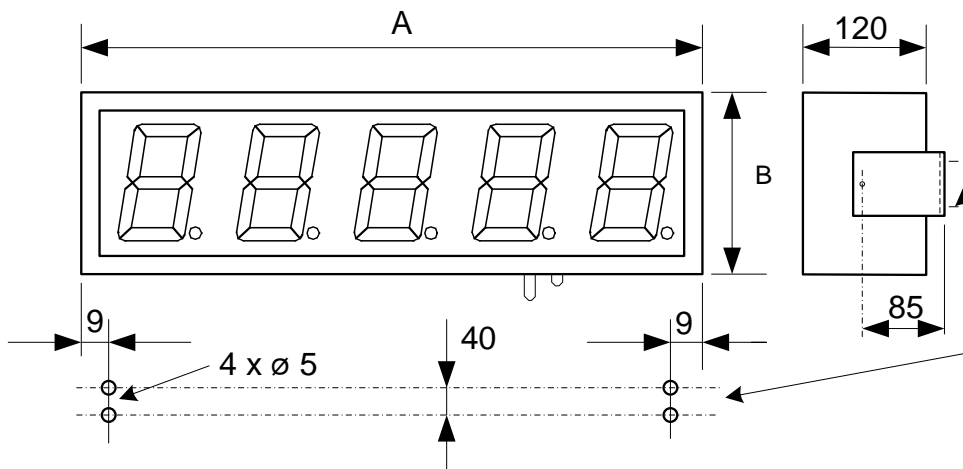

### 2.3.2. Dimensions and mounting of the DN-129 and DN-189

| Reference | A    | B   | C   | Reference    | A    | B   | C   |
|-----------|------|-----|-----|--------------|------|-----|-----|
| DN-189/3S | 500  | 251 | 67  | DN-189/3S+TV | 820  | 251 | 67  |
| DN-189/4S | 660  | 251 | 67  | DN-189/4S+TV | 980  | 251 | 67  |
| DN-189/5S | 820  | 251 | 67  | DN-189/5S+TV | 1140 | 251 | 67  |
| DN-129/3S | 750  | 366 | 186 | DN-129/3S+TV | 1220 | 366 | 186 |
| DN-129/4S | 985  | 366 | 186 | DN-129/4S+TV | 1455 | 366 | 186 |
| DN-129/5S | 1220 | 366 | 186 | DN-129/5S+TV | 1690 | 366 | 186 |

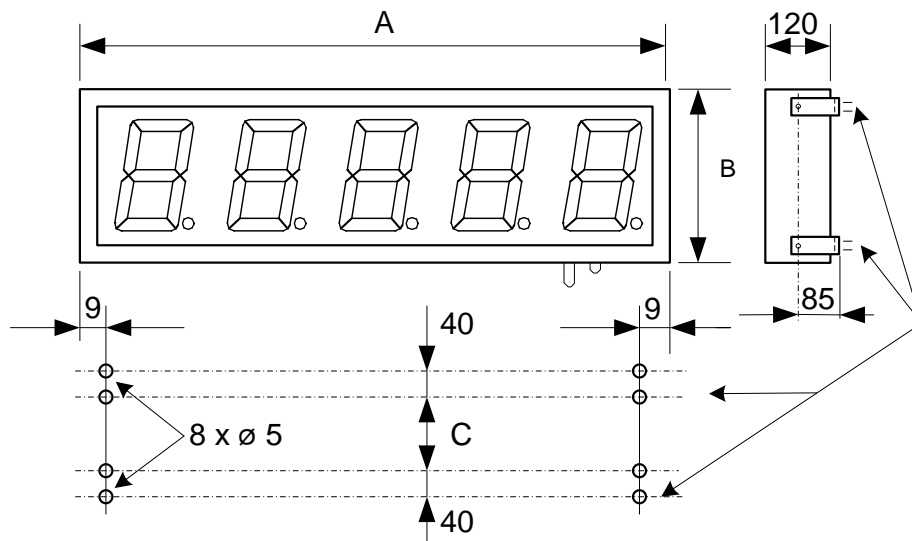

### 3. INSTALLATION

The installation of the DN-109AP, DN-119AP, DN-129AP and DN-189AP is not particularly delicate but some important considerations must be taken into account.

The display must not be anchored to places subject to vibrations, nor should it be installed in places which generally surpass the limits specified in the display characteristics, both in terms of temperature and humidity.

The degree of protection of displays DN-109AP, DN-119AP, DN-129AP and DN-189AP is IP41, meaning that they are protected against penetration by solid foreign objects of a diameter of about 1mm and against the vertical fall of water droplets.

Displays DN-109AP, DN-119AP, DN-129AP and DN-189AP should not be installed in places with an illumination level in excess of 1000 lux. Neither should the display be placed in direct sunlight as visibility would be lost.

In the electrical installation, proximity to lines of high intensity circulation and high voltage lines must be avoided, as well as proximity to High Frequency generators and U/F converters for motors.

#### 3.1. Power supply.

The power supply must be 88 to 264VAC, 47 to 63 Hz or 19 to 36VDC.

The power supply conductor section will be in line with consumption and the ground conductor will be a minimum section of 1.5m<sup>2</sup>.

The power supply connector for 220VAC has 3 contacts and is situated in the lower part of the unit. Connect the power wires following the schema below

The power supply connector for 24VDC has 4 contacts and is situated in the lower part of the unit. Connect the power wires following the schema below

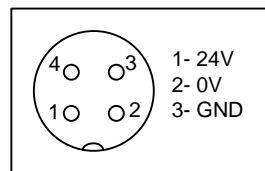
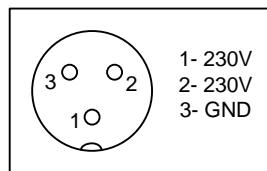

### 3.2. Position of the buttons and connectors

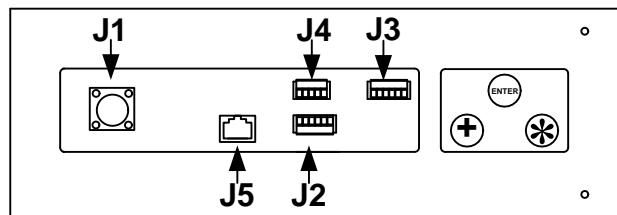

The signal connectors are situated in the lower part of the unit. Depending on the installed options, the unit will possess various types of connectors.

Connector **J2**: Analog inputs.

Connector **J3**: Relay output. Displays with option R

Connector **J4**: Remote keys. Displays with option K

Connector **J5**: Ethernet. Displays with option NE

The J1 power lead connector is placed in the lower part of the unit, except in DN-109/3AT models where this is in the upper part of the unit.

The buttons for configuration of the equipment are located in the lower part. They are identified with the symbols +, \* and the text «ENTER».

### 3.3. Analog inputs connection

In all the mountings, the connection of the inputs must be done using braided and insulated cable. The screen must only be connected to terminal 1 of the input connector.

**Terminals 5 and 6 of J2 are output power. Terminals 5 and 6 of J2 must NEVER be connected to a power supply.**

#### 3.3.1. Voltage input. 4 wire connection. External excitation

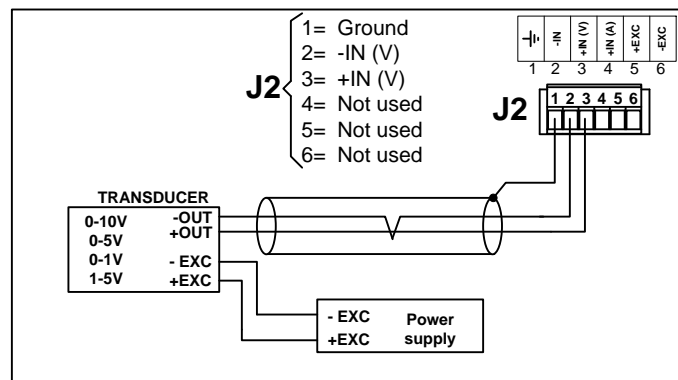

**3.3.2. Voltage input. 3 wire connection. External excitation**

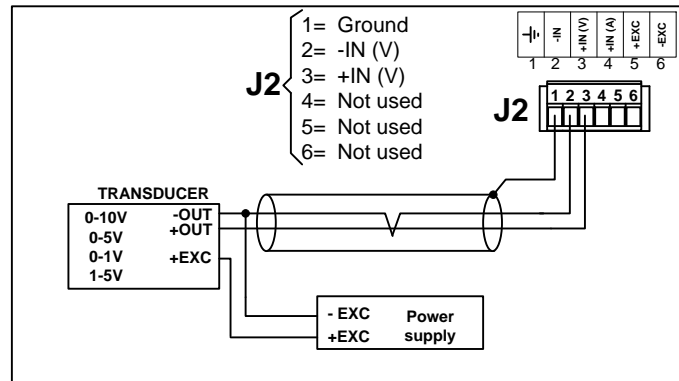

**3.3.3. Voltage input. 4 wire connection. Excitation supplied by display**

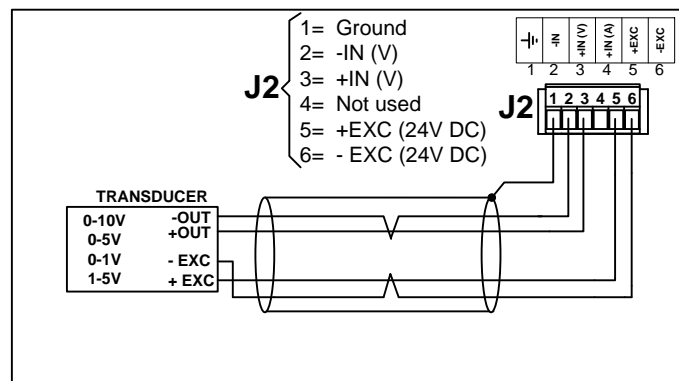

**3.3.4. Voltage input. 3 wire connection. Excitation supplied by display.**

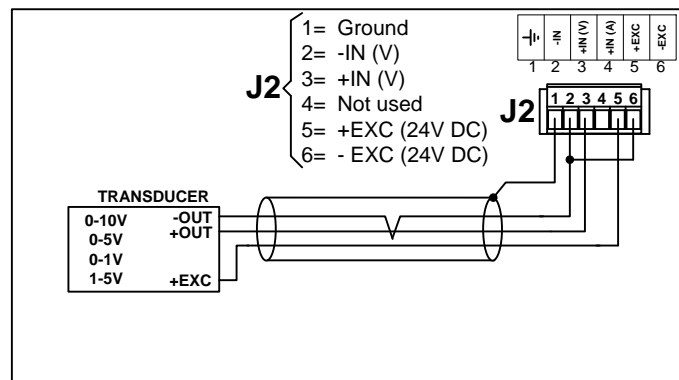

**3.3.5. Current input. 4 wire connection. External excitation.**

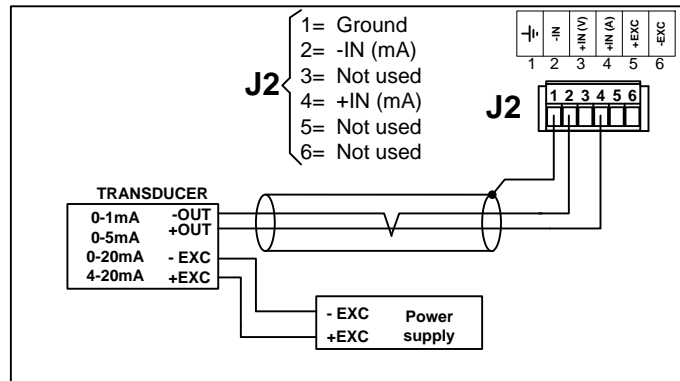

**3.3.6. Current input. 3 wire connection. External excitation.**

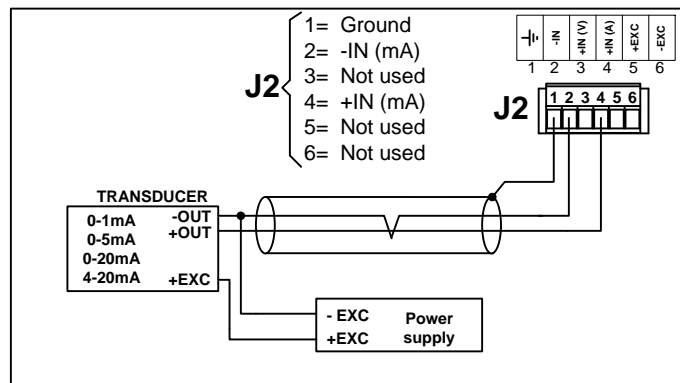

**3.3.7. Current input. 2 wire connection. External excitation.**

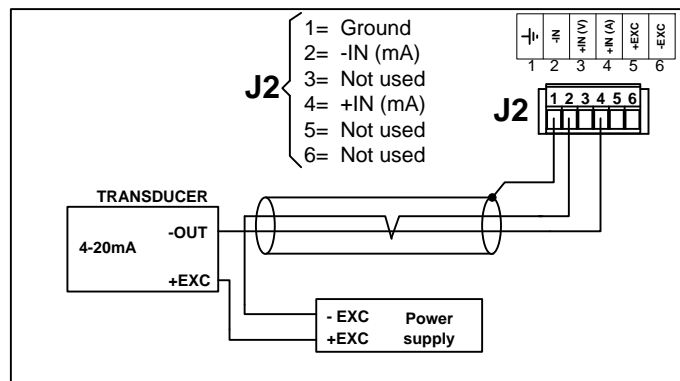

**3.3.8. Current input. 4 wire connection. Excitation supplied by display.**

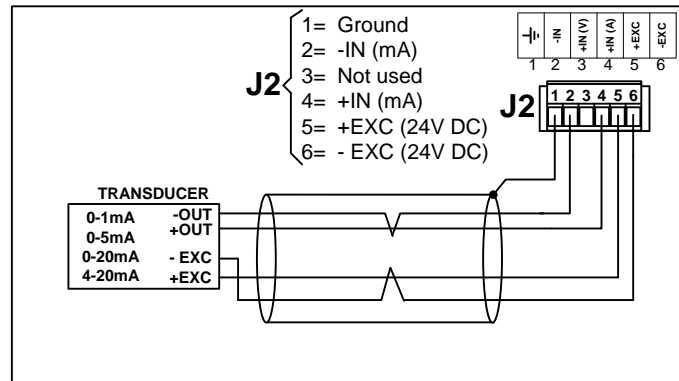

**3.3.9. Current input. 3 wire connection. Excitation supplied by display.**

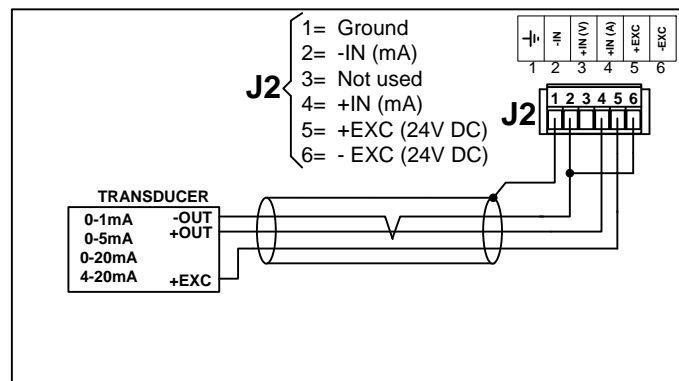

**3.3.10. Current input. 4 wire connection. Excitation supplied by display.**

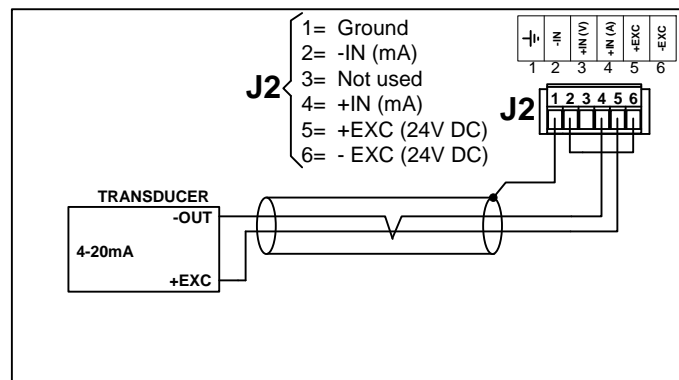



### 3.4. Connection of the remote keys.

The remote keys are connected as follows:

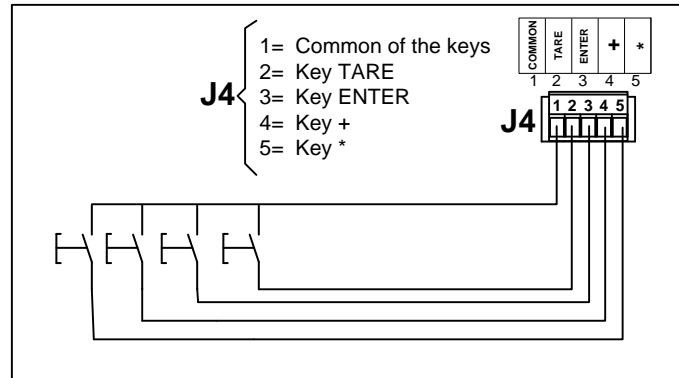

In the stainless steel box, the keys are connected through Terminal Blocks.

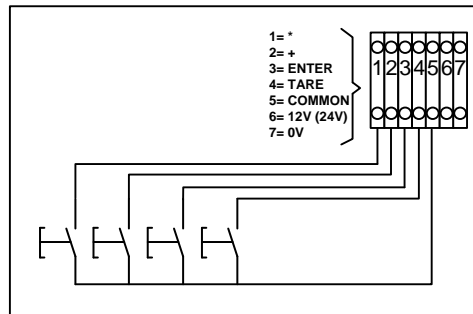

## 4. OPERATION

### 4.1. Initial reset.

Before connecting the display to the network, we must ensure that all of the connections have been carried out correctly and that the display is firmly in place.

Each time we connect the display to the power supply network, an initial reset occurs which tests all of the segments comprising the display. The test consists of the sequential illumination of all of the digits with the number "8", all of the digits with the value "0", all of the decimal points are lit up and finally the version code. From this point any one of the following three situations may occur:

- The display receives data from the serial line and displays it.
- The display does not receive data and the time without data equals zero. Keeps on showing the decimal points.
- The display does not receive data and the time without data is not equal to zero. After a time without data it displays a dash in each digit.

### 4.2. Programming parameters.

#### 4.2.1. Enter to modify parameters.

In order to enter the sequence to modify the parameters, the Advance key "\*" must be pressed and held for three seconds. After this, the first parameters will be displayed. The keys allow the user to move through the menu.



Advance key: Enter the parameter / Change the selected digit.



ENTER key. Validate the parameter value



Increase key. Increase the value of the selected digit. / Change parameter.

### 4.2.2. Configuration of the analog inputs

In addition to modifying the type of input (voltage or current), the range of the display must be programmed in order to adjust the value read to the value desired. The programming of the range is done by programming two points of the line. Each point is defined by a value from the analog input (IP1 and IP2) and a representation value in the display (dP1 and dP2). See Fig. 4.1. The maximum precision is achieved by programming the two points at the outer ends of the process.

In the processes in which the display value must vary in inverse relation to the input signal, one must assign the high display value to the low input value and the low display value to the high input value. See Fig.4.2

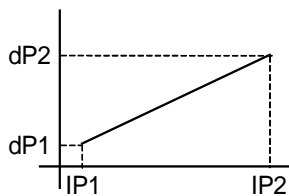

Fig 4.1

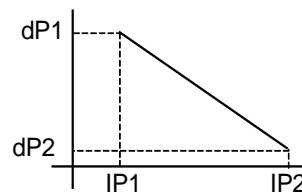

Fig. 4.2

The programming of the input values may be done in two ways: Entry by keys directly of the value (SCL) or by making the display read the input value and validating it through the keys. (tEA)

Programming through the keys (SCL): To be able to use this method, it is necessary to know the transducer specifications in the points IP1 and IP2 beforehand.

Programming by reading (tEA): To be able to use this method, it is necessary to have made the connection from the transducer to the display. When the values of IP1 and IP2 are shown, the current value read by the transducer is displayed instead of the last value programmed. Pressing ENTER validates the parameter.

Examples:

4-20mA humidity sensor

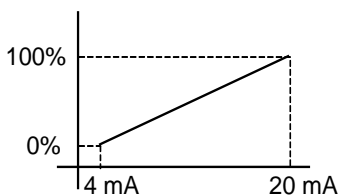

Parámetros a programar.

|     |      |     |       |
|-----|------|-----|-------|
| IP1 | 4,00 | IP2 | 20,00 |
| dP1 | 0    | dP2 | 100   |

Speedometer dynamo 5V/2500 rpm

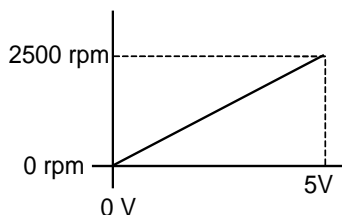

Parámetros a programar.

|     |      |     |      |
|-----|------|-----|------|
| IP1 | 0,00 | IP2 | 5,00 |
| dP1 | 0    | dP2 | 2500 |

### 4.2.3. Error displaying

---

**E0:** Input parameter error: IP2 must be greater than IP1

**E2:** Low level input signal. Wire broken or polarity error. Input signal must be  $> 0.9$  of IP1 or  $> 0.2$  if IP1 is  $> 1$ .

**E3:** High level input signal. Input signal must be  $< 1.1$  of IP2.

**E4:** Overrun while teaching process.

**-OE / OuE:** Overrun on 3 digits displays.

**-Oue / Oue:** Overrun on 4 or 5 digit displays.

### 4.2.4. Automatic decimal point.

---

Using this function, the decimal point is not static, but moves showing the maximum number of decimals in every case depending on the IP-dP parameters, always using all the digits available in the display.

### 4.2.5. Function of each parameter.

The parameters in the display are organized in 5 groups:

- Parameter InP: Input of the display
- Parameter dSP: Displaying characteristics ,
- Parameter FLH: Flashing of the digits. Only in displays without relays and colour options.
- Parameter rLS: Alarms of the display. In digits with relays and/or colour options.
- Parameter FI: Exit from menu.

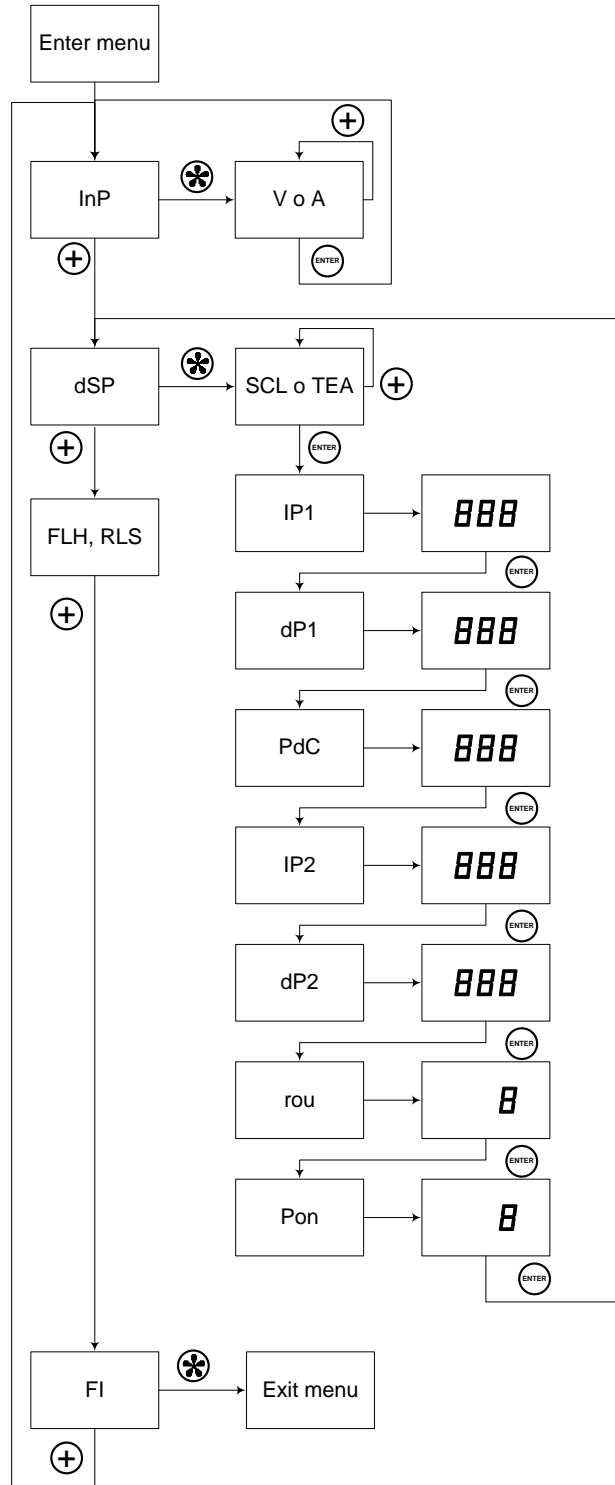

#### 4.2.5.1. Parameter InP

Input type menu. Upon pressing “\*”, the last type of input selected is displayed.

- -V- Voltage input selected. Press +\* to select current as input.
- -A- Input current selected. Press + to select voltage as input.

#### 4.2.5.2. Parameter dSP

Display scale adjustment menu. Upon pressing “\*”, one can select the direct input of values (DSP) or input through read values (TEA)

##### SCL

Upon pressing ENTER, one has direct access to the input of scale values.

##### tEA

Upon pressing ENTER, one has direct access to the entry of input values 1 and 2 from the value read by the analogue input.

##### IP1

Value of input 1. After 2 seconds, the last value programmed of input 1 is displayed (SCL mode) or the current value of the input (tEA mode), and is able to be modified. Upon pressing ENTER, the value is validated and the following parameter is accessed.

##### dP1

Display value corresponding to input 1. After 2 seconds, the last value programmed of display 1 is shown, and modification is permitted. Upon pressing ENTER, the value is validated and the following parameter is accessed. If the decimal point is in automatic mode, its position is modified pressing “+” until the last digit of the display is passed through. In that moment, the digit that flashes is the one where the decimal point is placed, as well as the digital point. Pressing “+” its position is modified.

##### PdC

Position of the decimal point. After 2 seconds, the last value programmed is shown and is permitted to be modified. To select automatic decimal point mode, press “\*” until all the digits flash. Upon pressing ENTER, the value is validated and the following parameter is accessed.

##### IP2

Value of input 2. After 2 seconds, the last value programmed of input 1 is displayed (SCL mode) or the current value of the input (tEA mode) and modification is permitted. Upon pressing ENTER, the value is validated and the following parameter is accessed.

##### dP2

Value of the display corresponding to input 2. After 2 seconds, the last value programmed of display 2 is shown and may be modified. Upon pressing ENETR, the value is validated and the following parameter is accessed. If the decimal point is in automatic mode, its position is modified pressing “+” until the last digit of the display is passed through. In that moment, the digit that flashes is the one where the decimal point is placed, as well as the digital point. Pressing “+” its position is modified.

### rou

---

This parameter defines the rounding of the last 2 digits of the display. It is used to eliminate oscillations in the value. Valid values:

1. Do not round.
2. Round the value in multiples of 2.
5. Round the value in multiples of 5.
10. Round the value in multiples of 10.

### Pon

---

Weighted of the display. The higher the value, more immune is the display to small variations at the input.

#### 4.2.5.3. Parameter FLH

---

This parameter makes the digits flash in the conditions the user programs the alarms.

The parameter “FLH” (Flash) admits the following values

|   |  |
|---|--|
| 0 | The digits don't flash                           |
| 1 | The digits flash when the alarm 1 is activated   |
| 2 | The digits flash when the alarm 2 is activated   |
| 3 | The digits flash if any alarm is activated       |
| 4 | The digits flash when both alarms are activated. |

To program the alarms, see 4.4 “Alarms configuration”

### 4.3. Taring the display.

The display allows the user to apply a tare to the display. To tare a display press the “Tare” key (only available in displays with option K through the external keys). The display will measure from this value. While the display is tared, the decimal point of the less weight digit flashes. To remove the tare, press the Tare key for 3 seconds.

With the tare activated, the overflow will be produced with voltages over 11V or lower than -200mV, currents over 22mA or lower than -200 $\mu$ A.



#### 4.4. Alarms configuration (flash, colour and relays)

The display allows the user to program 2 alarms that can be used by the flash, colour and relays functions. The trigger of the alarm can be delayed with a timer or by a hysteresis value. The activation of the alarm may be programmed so that it acts above or below the programmed setpoint.

The displays with the relay output option may generate control and alarm signals for their use by other units. The Flash function allows the digits to flash if one of the relays is activated.

The equipment that has the colour option may be programmed to display the value using colour red, green or yellow.

In displays with colour option, alarms may change the digits colours: Red, green or yellow.

The configuration of the alarms is accessed by two ways:

If the display has colour or relays option, the alarm configuration is accessed through the parameter rLS. Otherwise, it is accessed through the parameter FLH.

**4.4.1. Parameter map of the alarms**

The parameter map is the following if the display does not include nor colour nor relays option

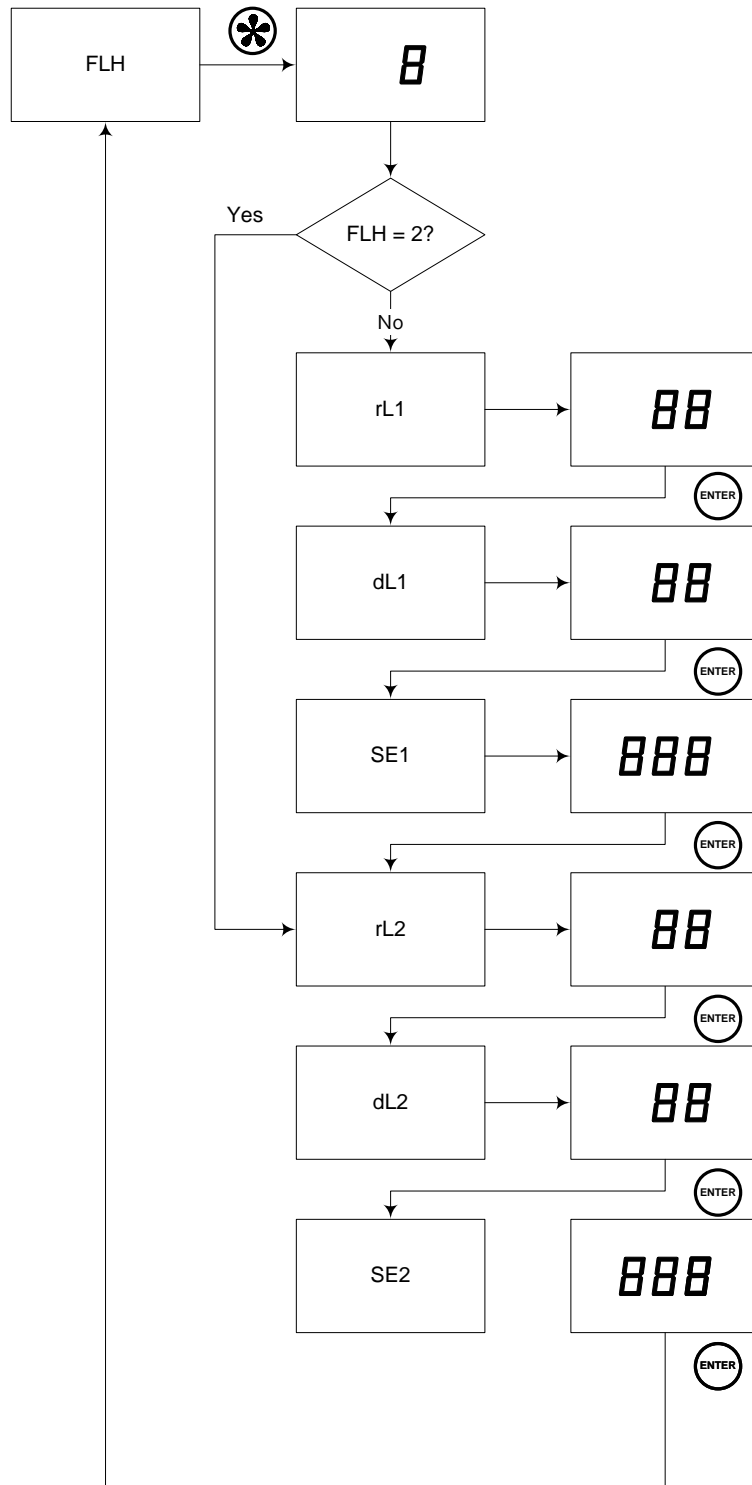

The parameter map is the following if the display includes the relay option but not the colour option.

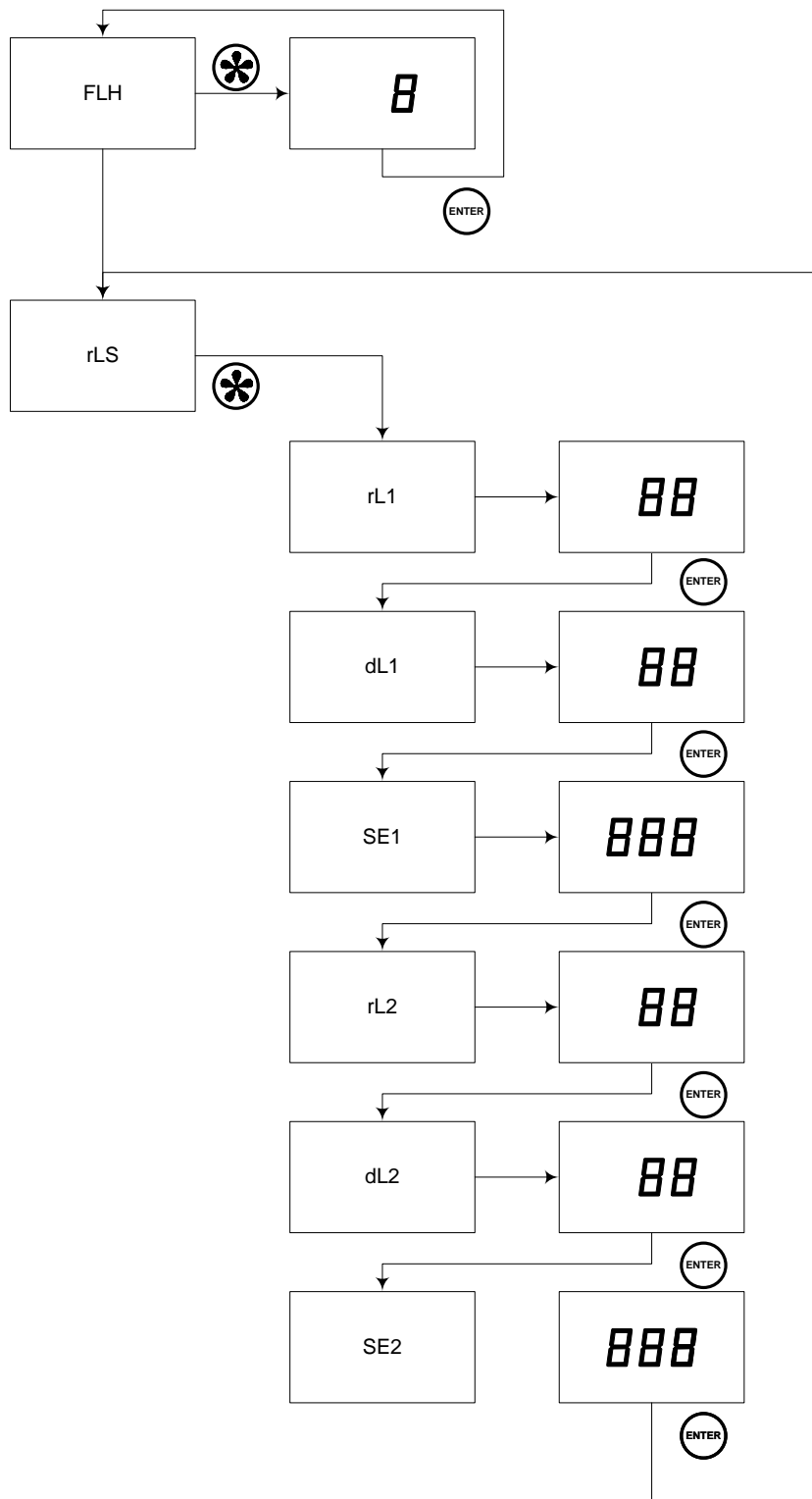

The parameter map is the following if the display includes the colour option.

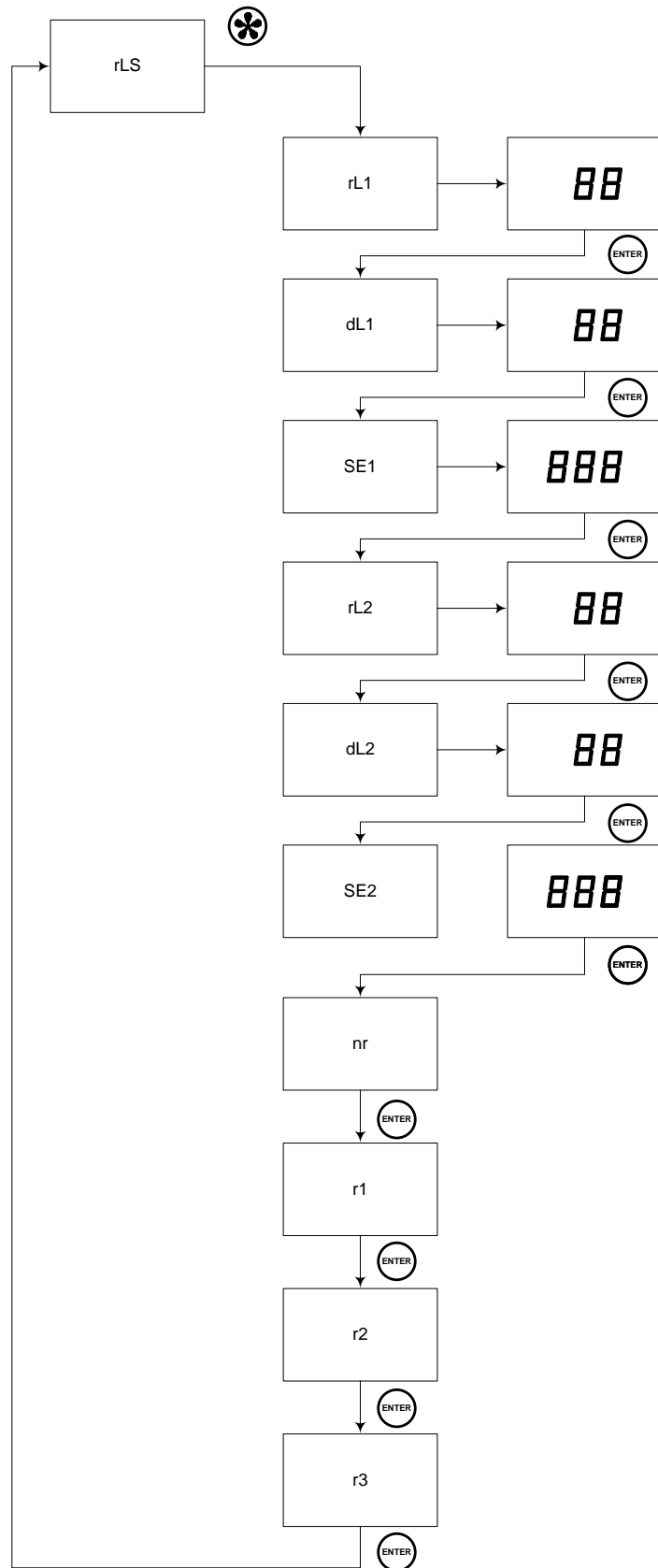

#### 4.4.2. Parameters for defining the alarm 1

In order to configure the alarm, parameters rL1., dL1 and SE1 must be accessed.

##### rL1

Alarm 1 configuration. After 2 seconds, the last value programmed is displayed and permitted to be modified. Upon pressing ENTER the value is validated and the next parameter is accessed. Each one of the two digits has a distinct function.

| Left digit | Control bit              | Right digit | Activation |
|------------|--------------------------|-------------|------------|
| 0          | ON if Value > Setpoint 1 | 0           | Delay      |
| 1          | ON if Value < Setpoint 1 | 1           | Hysteresis |
| 2          | Always OFF               |             |            |

##### dL1

Delay time (in seconds) or hysteresis (2 less significant digits) value of alarm 1. After 2 seconds, the last value programmed is displayed and permitted to be modified. Upon pressing ENTER the value is validated and the next parameter is accessed.

##### SE1

Set point value of alarm 1. After 2 seconds, the last value programmed is displayed and permitted to be modified. Upon pressing ENTER the value is validated and the next parameter is accessed.

### 4.4.3. Parameter for defining the alarm 2

In order to configure the alarm 2, parameters rL2., dL2 and SE2 must be accessed.

#### rL2

Alarm 2 configuration. After 2 seconds, the last value programmed is displayed and permitted to be modified. Upon pressing ENTER the value is validated and the next parameter is accessed. Each one of the two digits has a distinct function.

| Left digit | Control bit              | Right digit | Activation |
|------------|--------------------------|-------------|------------|
| 0          | ON if Value > Setpoint 1 | 0           | Delay      |
| 1          | ON if Value < Setpoint 1 | 1           | Hysteresis |
| 2          | Always OFF               |             |            |

#### dL2

Delay time (in seconds) or hysteresis (2 less significant digits) value of alarm 2. After 2 seconds, the last value programmed is displayed and permitted to be modified. Upon pressing ENTER the value is validated and the next parameter is accessed.





#### SE2

Set point value of alarm 2. After 2 seconds, the last value programmed is displayed and permitted to be modified. Upon pressing ENTER the value is validated and the next parameter is accessed.

#### 4.4.4. Parameters to define the colour.

To define the colour the 2 alarms are used.

The following parameters are used to define colours.

|   |   |
|---|---|
|  | Colour if internal bits are OFF. To change the colour push * key. Upon pressing + the next parameter is shown.                        |
|  | Colour if internal bit <b>r1</b> is ON. To change the colour push * key. Upon pressing + the next parameter is shown.                 |
|  | Colour if internal bit <b>r2</b> is ON. To change the colour push * key. Upon pressing + the next parameter is shown.                 |
|  | Colour if internal bits <b>r1</b> and <b>r2</b> are ON. To change the colour push * key. Upon pressing + the next parameter is shown. |

#### 4.4.5. Characteristics of the relay output option.

SPDT contact.

Maximum current:

Resistive load ..... 5A

Inductive load ..... 5A

Maximum voltage: ..... 60V AC/DC

#### 4.4.6. Wiring the relay output

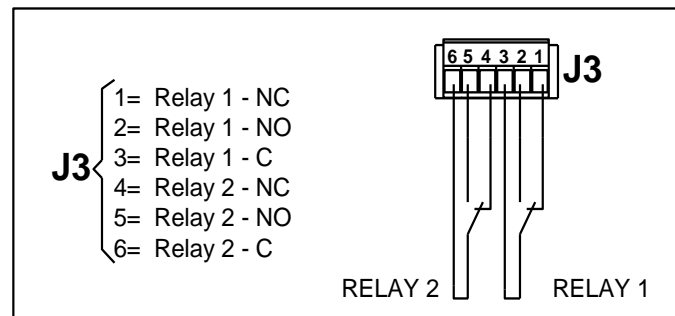

## 4.5. Ethernet option

Ethernet options allows a new step in this displays type because it allows to connect displays using the same LAN in the installation, syncing them through the SNTP and providing a new user interface through the Web.

### 4.5.1. The first connection

There are several ways for accessing the display on the first time it's connected to the network.

One of the ways is changing the IP address through parameters seen before

If the IP 192.168.1.100 (the default IP of the display) is in the range of your LAN, the display can be accessed typing the IP in the URL bar in your favourite browser.

In case there is more than one display in the LAN or the default IP of the display is out of the IP range of you LAN, it is recommended to use the PC program "Display Discoverer", downloadable from the web. In this program, the displays connected to the LAN are displayed, as well as their IP addresses, their MAC addresses (all MAC are 00:04:A3:xx:xx:xx) and its name. The default name of the display is its serial number. This name can be changed in the Ethernet tab of the web server of the display. If a display is selected, by clicking "identify Display", the selected display will flash for 3 seconds.

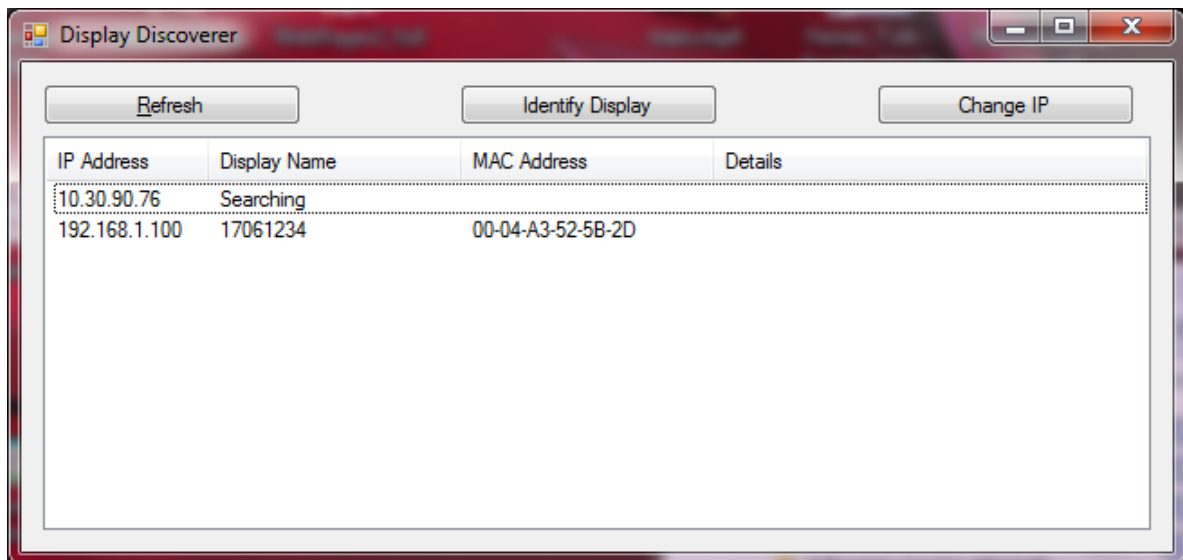

The first row shows the IP of the PC which is searching the displays and the second row a display we just have bought. As it is shown, the display has serial number 17061234 and the default IP is out of the range of the LAN. To change the IP address to a suitable one for our LAN, select the display and click the button "Change IP". When clicking this, a new window is opened where a new IP address can be typed.



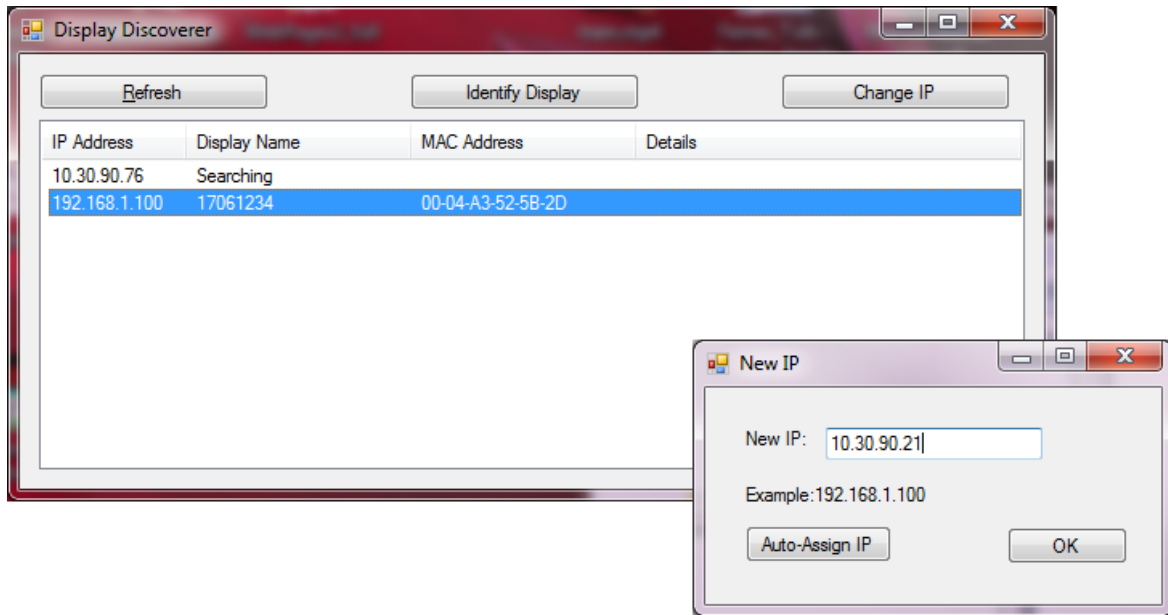

Tip the new IP and click OK. There will appear a message in the main window with the message sent to the display.

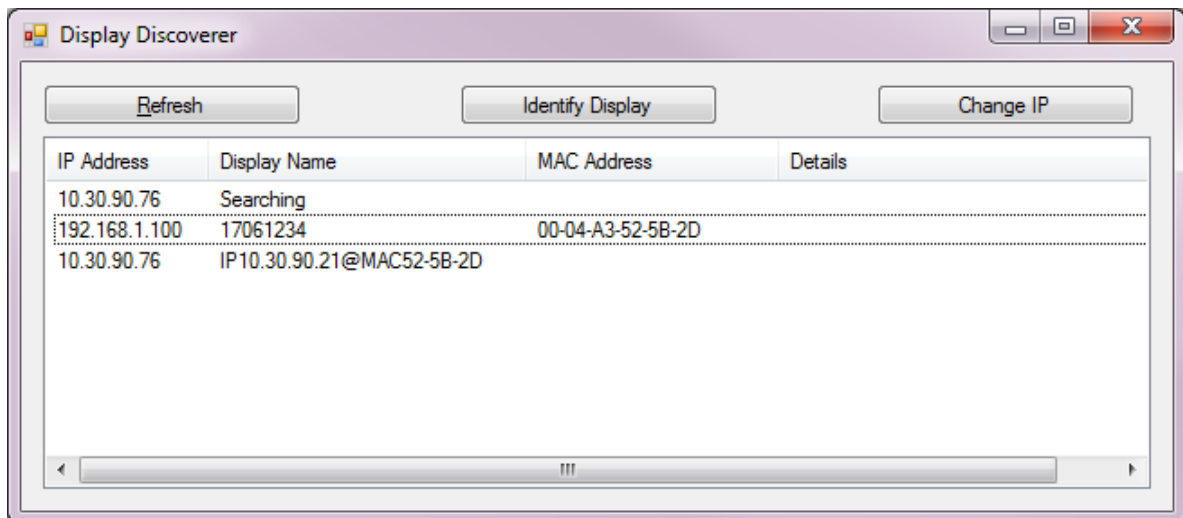

After some seconds, click the “Refresh” button. The display appears with the new IP

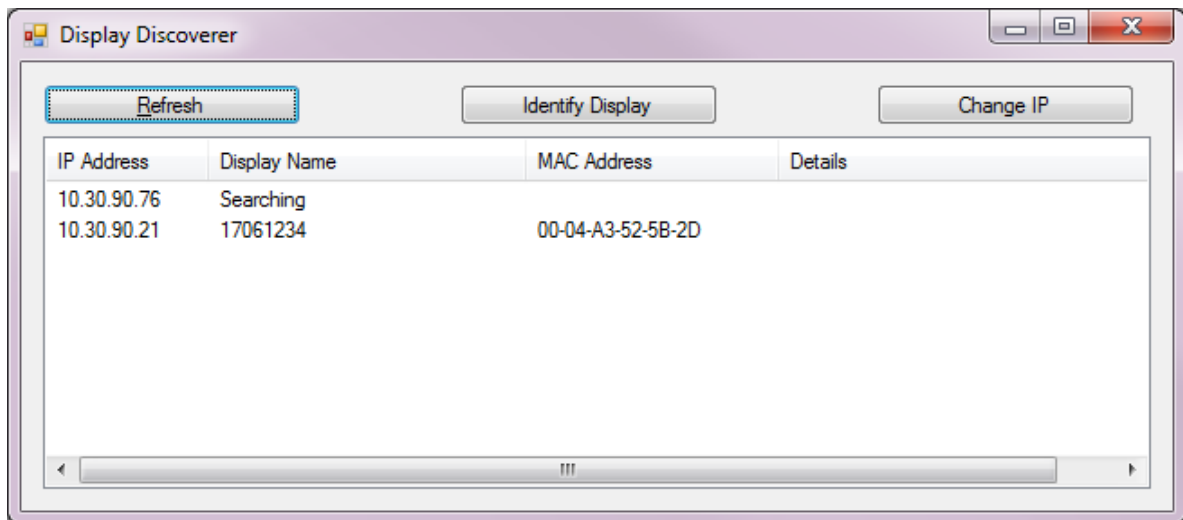

Click the display IP to open a new tab in the browser. The main page of the web server is shown.

### 4.5.2. User interface

Ethernet connection allows a new interface, much easier than the usual in displays. All configuration can be done through a website hosted at the display, so the user only needs a device connected to the LAN with web browser (computers, smartphones, tablets...). There is no contact with the display, which usually is in a difficult access point. The web page can be accessed remotely if the router is correctly redirected. See **Error! Reference source not found.** for more information.

The main page shows the value of the display, as well as the measurement name and unit (configured by the user) and the relays status (if option added). This main page is for the user to control the status of the display.

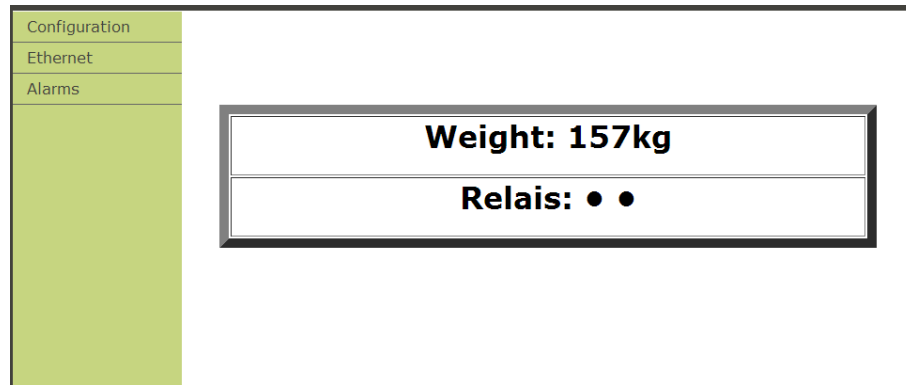

In the left menu there are three tabs: Configuration, Ethernet and alarms, accessible through user and password:

|                    |
|--------------------|
| User: admin        |
| Password: 12345678 |

First tab allows the user to configure the same parameters as the parameter menu in an easier and more intuitive way. Using this menu, the user selects the process input (voltage or current), ponderation, decimals. Magnitude and unit of measure are configured only for displaying issues. In the points of the displaying line, the displayed values correspond to dP values in the key menu and Measured values correspond to IP values.

|          |                                      |           |                    |  |
|----------|--------------------------------------|-----------|--------------------|--|
| Display  | <b>Configuration</b>                 |           |                    |  |
| Ethernet |                                      |           |                    |  |
| Alarms   |                                      |           |                    |  |
|          | <b>Configuration analog port</b>     |           |                    |  |
|          | Process input:                       | Voltage ▾ | Pond               | 0 ▾  |
|          | Round                                | 1 ▾       | Number of decimals | 0 ▾  |
|          | <b>Magnitude</b>                     |           |                    |  |
|          | Magnitude                            | Peso      | Unit of measure    | kg   |
|          | <b>Points of the displaying line</b> |           |                    |  |
|          | Displayed value (min).               | 00.000    | Measured value (V) | 00.000 <input type="button" value="Teach"/>                  |
|          | Displayed value (max).               | 20.000    | Measured value (V) | 20.000 <input type="button" value="Teach"/>                  |
|          |                                      |           |                    | <input type="button" value="Validate analog configuration"/> |
|          | <b>Web configuration</b>             |           |                    |  |
|          | Password                             | .....     |                    | <input type="button" value="Validate"/>                      |
|          | Language                             | English ▾ |                    |  |

The tab “Alarms” allows the user to configure the alarms of the displays, as well as the flashing of the digits in the displays without color and the color in the displays with that option. The relays are activated by the alarms (relay 1 with alarm 1 and relay 2 with alarm 2). In this example, the alarm 1 will activate 10 seconds after the value of the display goes lower than 100 and will deactivate 10 seconds after the value of the display goes higher than 100. Alarm 2 will activate when the value of the display goes higher than 205 and will deactivate when the display goes lower than 200.

The image corresponds to a display without the color option. In this case, the digits will flash when the alarm 2 is activated.

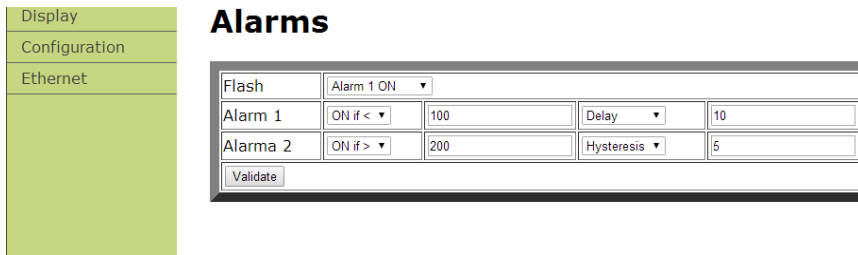

The following image corresponds to a display with colour option. The colour of the display will depend of this configuration

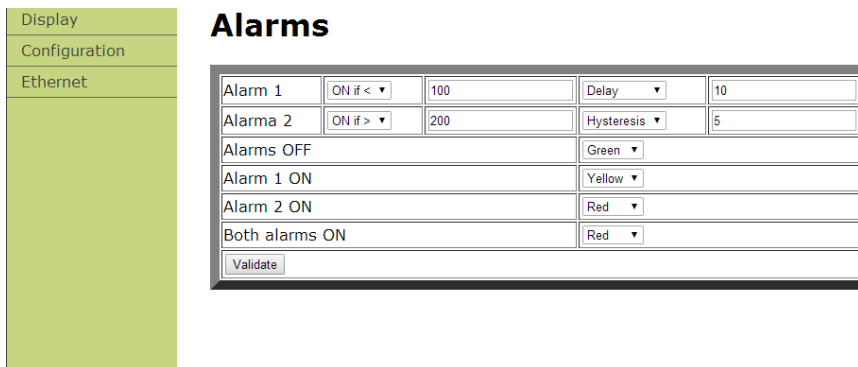

The Ethernet tab allows configuring the network parameters of the display, including the IP address, DNS, etc. The display can use DHCP to get these parameters on its own. The name of the display can be changed according to the needs of the user. This name is used to identify and access the display through web browser (typing the name in the URL)

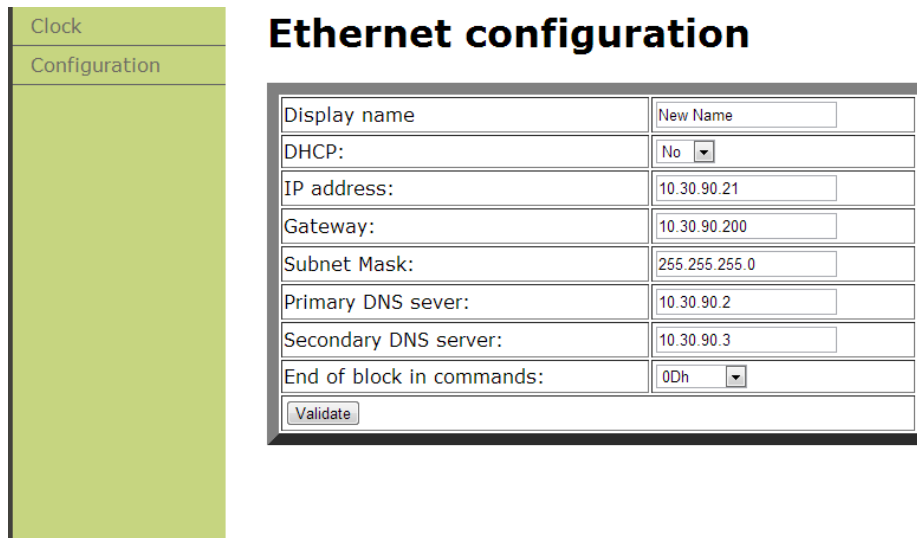

| Ethernet configuration                  |  |
|---|--|
| Display name                            | <input type="text" value="New Name"/>      |
| DHCP:                                   | <input type="text" value="No"/>            |
| IP address:                             | <input type="text" value="10.30.90.21"/>   |
| Gateway:                                | <input type="text" value="10.30.90.200"/>  |
| Subnet Mask:                            | <input type="text" value="255.255.255.0"/> |
| Primary DNS sever:                      | <input type="text" value="10.30.90.2"/>    |
| Secondary DNS server:                   | <input type="text" value="10.30.90.3"/>    |
| End of block in commands:               | <input type="text" value="0Dh"/>           |
| <input type="button" value="Validate"/> |  |

In case of failure or errors, reset the display by pressing the three keys all during a reset.

### 4.5.3. Ethernet parameter configuration

The Ethernet parameters, like the IP address, the Gateway, the subnet mask, etc can be configured manually or automatically through DHCP. Previously, the user must know the IP address he wants for the display. It is highly recommended to change the IP address from the default.

Once the user has accessed the Ethernet tab of the display webpage, configure the parameters manually or activate the DHCP protocol for the display to request all the network parameters automatically. When clicking the button “validate”, the system saves the changes and reboots. If the parameters are put manually, the work is finished.

On the other side, the display may have changed the IP address. This IP address can be checked (and changed) through parameters or the “Display Discoverer”. The DHCP can be left enabled or disabled. If the user modifies the IP address, the DHCP protocol will be disabled.

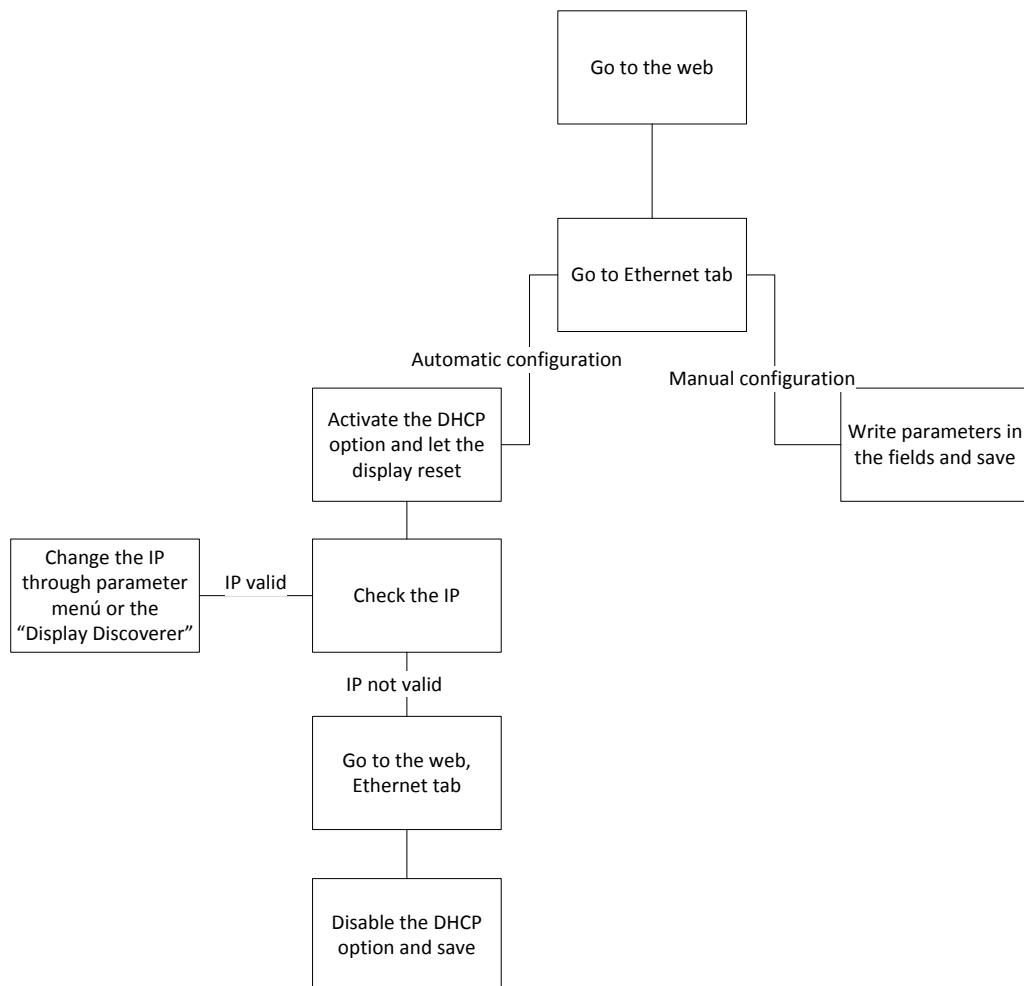

#### 4.5.4. Communication with commands through Ethernet

The displays can obtain the displayed value through commands. The frames are sent in ASCII (character) format. The end of block is the one defined by the user through the web page. The port the commands must be sent to is 9760.

##### Frame

This frame only includes the code. This does not send any data.

|              | Code    | End of block |
|--------------|---------|--------------|
| <b>ASCII</b> | P A     |              |
| <b>Hexa</b>  | 50h 41h |              |

##### Response frame

|              | Code    | Data | End of block |
|--------------|---------|------|--------------|
| <b>ASCII</b> | R A     |      |              |
| <b>Hexa</b>  | 52h 41h |      |              |

Example: 123.45

|              | Code    | Data |     |     |     |     |     | End of block |
|--------------|---------|------|-----|-----|-----|-----|-----|--------------|
| <b>ASCII</b> | R A     | 1    | 2   | 3   | .   | 4   | 5   |              |
| <b>Hexa</b>  | 52h 41h | 31h  | 32h | 33h | 2Eh | 34h | 35h |              |



## Revision history

### **Revision J (March 2013).**

Updated introduction in 4.4.

### **Revision K (September 2013).**

Added 3.4.

Added 4.3.

Added function round in 4.2.4.

Updated dimensions and weight of DN-109/3. Paragraphs 2.2.1 and 2.3.1.

### **Revision L (October 2013)**

Moved 4.4 to 4.5.3.

Updated electrical characteristics of the 24VDC power. Paragraphs 2.1 and 3.1.

Added the "Flash" function. Paragraph 4.4.4

Updated paragraph 4.4.4

### **Revision M (March 2013)**

Updated paragraph 3.2.

Updated images in paragraph 3.3 and 3.4.

Updated paragraph 3.4.3 and 4.4.

Deleted paragraph 4.5.

### **Revision N (March 2014)**

Updated paragraph 4.2

Added paragraph 4.5

### **Revision P (May 2017)**

Statement of conformity modification.

## **STATEMENT OF CONFORMITY**



DISEÑOS Y TECNOLOGIA, S.A.  
Poligon Industrial Les Guixeres  
c/ Xarol 8C  
08915 BADALONA España

As the builder of the equipment of the **DITEL** brand:

Model : DN-109AP in all versions.  
Model : DN-119AP in all versions.  
Model : DN-129AP in all versions.  
Model : DN-189AP in all versions.

We declare under our sole responsibility that the aforementioned product complies with the following European directives:

Directive: LVD 2006/95/CEE Low Voltage Directive.  
Standard UNE-EN61010-1 Security in electric equipment.

Directive: EMC 2014/30 UE Electromagnetic Compatibility  
Standard UNE-EN 61000-6-4 Generic Emission Standard. Industrial environment.  
Standard UNE-EN 61000-6-2 Generic Immunity Standard. Industrial environment.  
Directive 2011/65/CE: Restriction of the use of certain hazardous substances in electrical and electronic equipment

Badalona, 29th January 2014

A handwritten signature in black ink, appearing to read 'Alicia Alarcia', is centered below the date.

Alicia Alarcia  
Technical Director