

# KOSMOS SERIES

## INSTRUCTIONS MANUAL PROGRAMMABLE PULSE COUNTER WITH TOTALIZER

CE



CODE: 30727151 EDITION: 08-09-2006



## JUNIOR-IMP JUNIOR20-IMP

# INTRODUCTION TO THE KOSMOS SERIES

**This manual does not constitute a formal agreement. All information given in this manual is subject to change without notice.**

The KOSMOS SERIES brings a new philosophy in digital panel instrumentation, which is expressed by multipurpose, modular-concept devices providing a rich array of basic functions and advanced capabilities.

With a fully MODULAR DESIGN, it is possible to implement a wide variety of applications by only adding the adequate options.

Intelligence within allows the meter to recognize the options installed and ask for the necessary parameters to properly function within desired margins. The basic instrument without output options omits these data in the program routines.

The instrument CALIBRATION is realized at the factory eliminating the need for adjustment potentiometers. Any circuit or option liable to be adjusted incorporates a memory where calibration parameters are stored, making it possible the optional cards be totally interchangeable without need of any subsequent adjust.

Custom CONFIGURATION for specific applications can be made quickly and easily through five front panel keys, following structured choice menus aided by display prompts at each programming step.

Other features of the KOSMOS family include:

- CONNECTIONS via plug-in terminal blocks without screws and CLEMP-WAGO clips cable retention system.
- DIMENSIONS  
Models ALPHA & BETA 96 x 48 x 120 mm DIN 43700  
Models MICRA & JR/JR20 96 x 48 x 60 mm DIN 43700
- CASE MATERIAL UL-94 V0-rated polycarbonate.
- PANEL INSTALLATION by means of single part fingertip without screws.

To guarantee the meter's technical specifications, its is advised to check calibration parameters at periodical intervals according to the ISO 9001 standards for the particular application operating criteria. Recalibration of the meter should be made at the factory or in a qualified laboratory

Valid for instruments from 232851

# JUNIOR-IMP & JUNIOR20-IMP

## INDEX

1. MODELS JR/ JR20-IMP OVERVIEW .....	4-5
1.1. - FRONT-PANEL DESCRIPTION .....	6-7
2. SET UP AND OPERATION .....	8
2.1 - POWER SUPPLY AND CONNECTORS .....	9-10
2.2 - PROGRAMMING INSTRUCTIONS .....	11
2.3 - INSTRUMENT SET UP .....	12-13
2.4 – INPUT CONNECTION.....	14-15
2.5 - INPUT PROGRAMMING .....	16
2.6 – DISPLAY CONFIGURATION.....	17-18
2.7 – TOTALIZER, OFFSET, RESET AND MULTIPLICATION FACTOR .....	19
3. SETPOINTS OUTPUT. BOARD CONNECTION .....	20
3.1 - MODES .....	21-22
3.2 - PROGRAMMING.....	23
3.3 – PARAMETERS CONFIGURATION.....	24-25
4. SPECIFICATIONS	
4.1 - TECHNICAL SPECIFICATIONS .....	26
4.1 - DIMENSIONS AND MOUNTING .....	27
5. WARRANTY.....	28
6. DECLARATION OF CONFORMITY.....	29

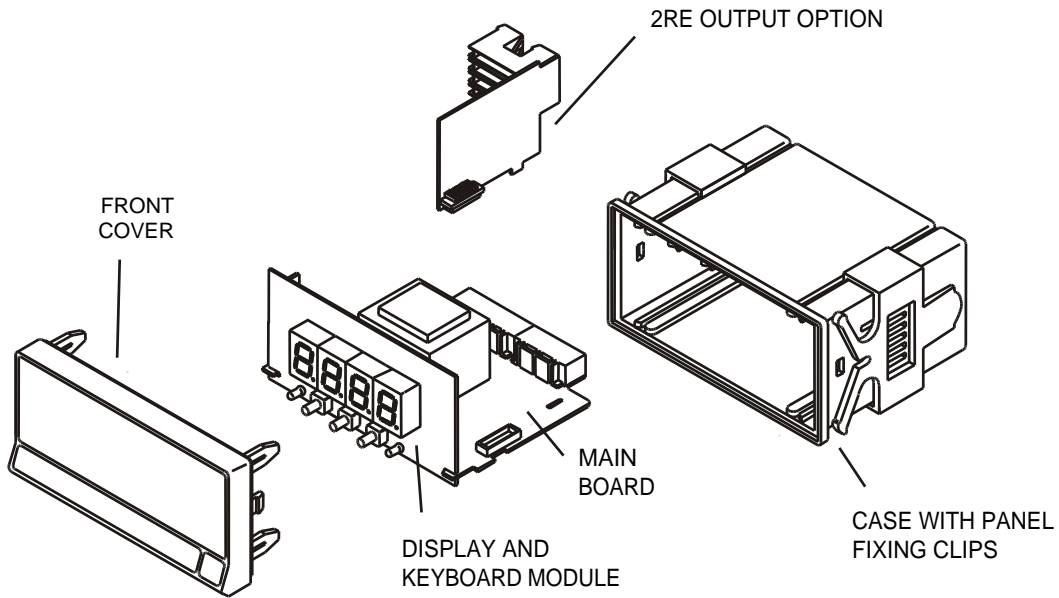

# 1. MODELS JUNIOR-IMP and JUNIOR20-IMP

This manual describes the models Junior-IMP and Junior20-IMP both instruments are small format.

The difference between both models is the size of the digits of the display. Model JR20-IMP provides 20 mm-high digits which make it easy readable at long distances. In this manual both models are referred with the generic name of JR/ JR20-IMP.

Totally configurable by software, the models JR/ JR20-IMP are counters that can provide two variables; the number of pulses of actual process, and a total of accumulated pulses from several partial counting, both scaled by a programmable factor. The TOTAL can be 999999. The visualization of TOTAL is done by a key on the front showing the 3 most significant digits first and the 3 lest significant digits after in an alternating way.

The counting is unidirectional, always up, starting from zero or from a programmable offset value.

The user can select the following parameters: decimal point position, lock of reset key, scaling factor programmable from 0.001 to 9.999, anti debounce filter of 20Hz, offset (initial counting value) programmable from 0 to 9999.

The basic instrument is a soldered assembly composed of the main board, and the display and keyboard module.

Optionally, it can be equipped with a 2-relay control output card (2RE). This option provides an output connector at the rear of the meter; status LED's visible from the front and specific programming routines, which are enabled automatically once the card is installed.

The outputs are isolated from signal input and power supply



This instrument conforms the following community standards: 89/336/CEE and 73/23/CEE  
**WARNING:** Refer to the instructions manual to preserve safety protections.

# FRONT-PANEL FUNCTIONS DESCRIPTION (RUN MODE)

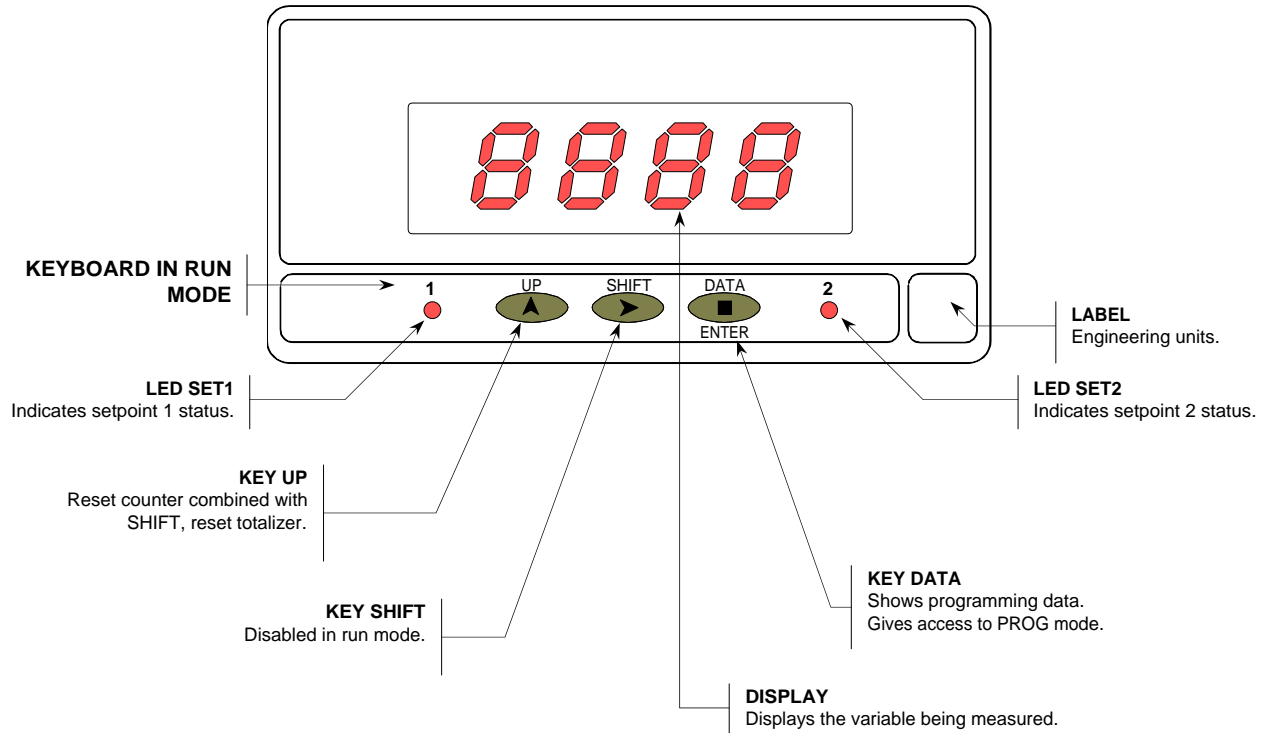

# FRONT-PANEL FUNCTIONS DESCRIPTION (PROG MODE)

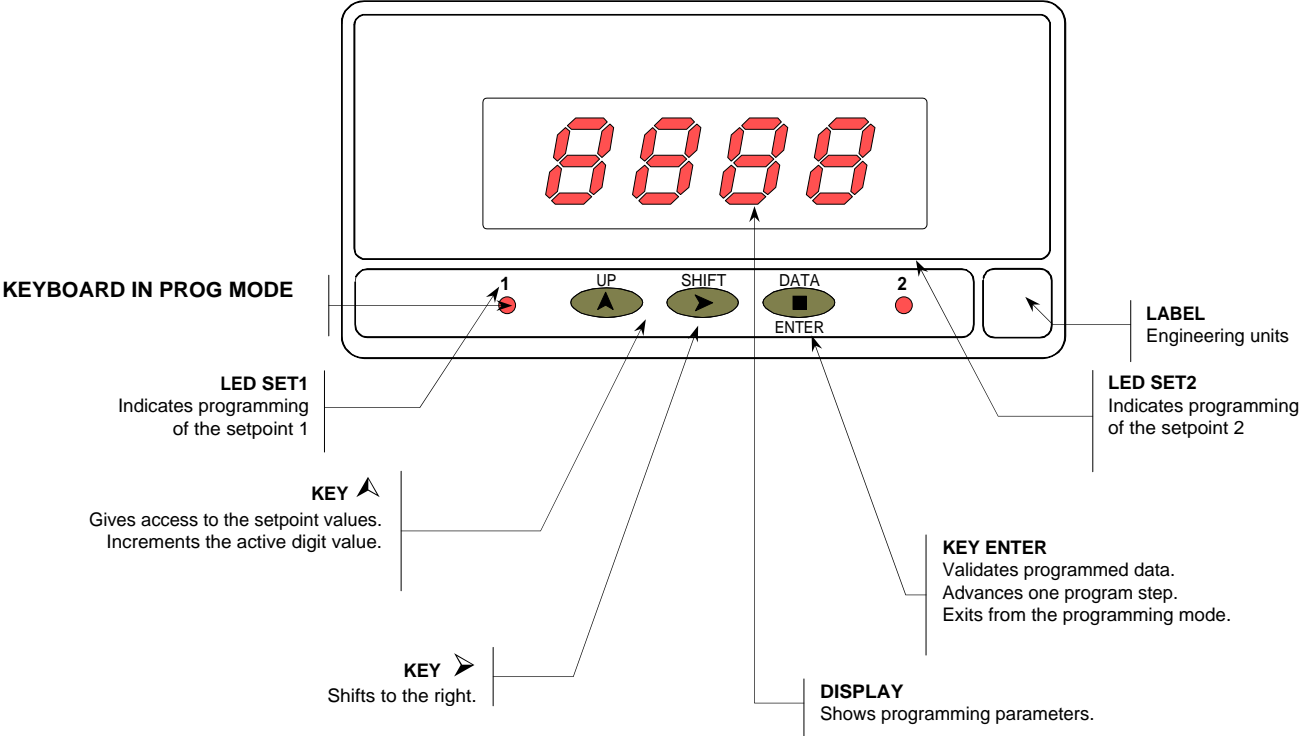

## 2. OPERATING INSTRUCTIONS

### PACKING CONTENTS

- ❑ Instructions manual in English including Declaration of Conformity.
  - ❑ The digital panel instrument JR/ JR20-IMP.
  - ❑ Accessories for panel mounting (sealing gasket and fixing clips).
  - ❑ Accessories for wiring connection (removable terminal block connectors and fingertip).
  - ❑ Wiring label stuck to the instrument's case JR/ JR20-IMP
  - ❑ Set of 4 labels with different engineering units.
- ✓ **Check packing contents.**

### CONFIGURATION

Power supply (pages 9 & 10)

- ❑ The instruments for 115/230V AC power supply are set up at the factory for 230V AC. (USA market 115 V AC).
  - ❑ The instruments for 24/48V AC power supply are set up at the factory for 24V AC.
  - ❑ If the instrument is supplied for 12V DC, 24V or 48V DC power supply, it is not necessary to make any change.
- ✓ **Check wiring label before connecting the instrument to the supply.**

Programming instructions (page 11)

- ❑ The software inside the instrument allows configuring the input and display parameters. If a two-relay output option is installed ref. 2RE (page 27), the software detects it on power up enabling a specific routine for setpoints configuration.
- ✓ **Read carefully this paragraph.**

Input type (page 12-15)

- ❑ The instrument provides an input for several sensor types including magnetic pickup, Namur, NPN/PNP type and TTL/24V DC (see page 13).
- ✓ **Check the 5-position DIP-switch located on the main board.**

Programming lockout (page 26)

- ❑ As shipped from the factory, the instrument allows full access to change programming parameters. To disable the possibility of making changes on the configuration, it is necessary to remove a plug-in jumper located on the main board.
- ✓ **Check jumper position.**



## 2.1 – Power supply and connectors

To change the meter's physical configuration remove the case as shown in figure 9.1.

**115/230 V AC:** The instruments with 115/230 V AC power are set up at fabrication for 230 V AC (USA market 115 V AC), see figure 9.2. To change power supply configuration to 115 V AC, make the jumpers indicated in figure 9.3 and table 1. The wiring label should be modified to match the new configuration.

**24/48 V AC:** The instruments with 24/48 V AC power are set up at fabrication for 24 V AC, see figure 9.2. To change power supply configuration to 48 V AC, make the jumpers indicated in figure 9.3 and table 1. The wiring label should be modified to match the new configuration.

**12, 24 or 48V DC:** Instruments for DC power are set up for the supply voltage specified in the wiring label (12V, 24V or 48V according to the order reference).

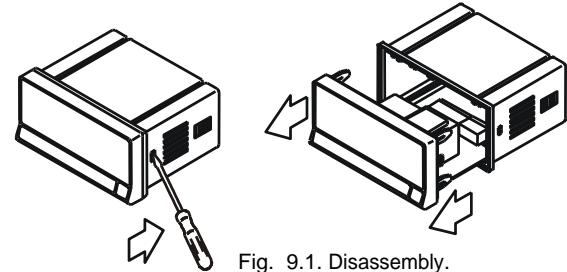

Fig. 9.1. Disassembly.

Table 1. Jumper settings. .

Pin	1	2	3	4	5
230V AC	-	[Jumper]		[Jumper]	
115V AC	[Jumper]		[Jumper]		-
48V AC	-	[Jumper]		[Jumper]	
24V AC	[Jumper]		[Jumper]		-

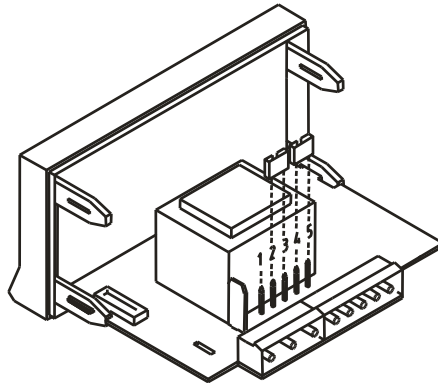

Fig. 9.2. Jumper settings for 230 V or 48 V AC

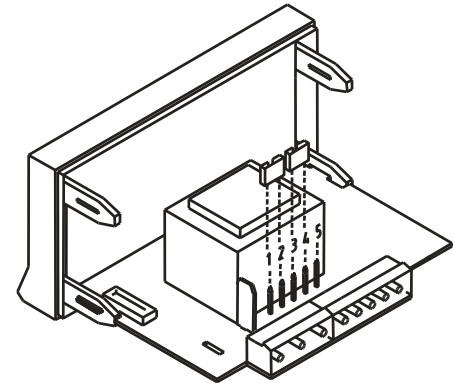
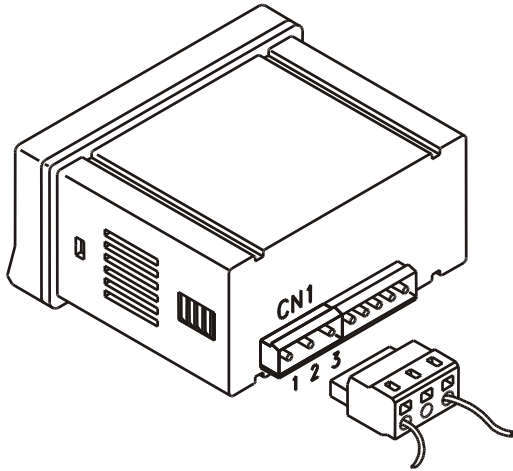

Fig. 9.3. Jumper settings for 115 V or 24 V AC

## POWER CONNECTION



### AC VERSIONS

PIN 1 – AC PHASE

PIN 2 – GND (GROUND)

PIN 3 – AC NEUTRAL

### DC VERSIONS

PIN 1 – DC POSITIVE

PIN 2 – Not connected

PIN 3 – DC NEGATIVE



WARNING

### INSTALLATION

To meet the requirements of the directive EN61010-1, where the unit is permanently connected to the mains supply it is obligatory to install a circuit breaking device easy reachable to the operator and clearly marked as the disconnect device.

### WARNING

In order to guarantee the electromagnetic compatibility, the following guidelines should be kept in mind:

- Power supply wires may be routed separated from signal wires. Never run power and signal wires in the same conduit.
- Use shielded cable for signal wiring and connect the shield to the ground of the indicator (pin2 CN1).
- The cables section should be  $\geq 0.25 \text{ mm}^2$

**If not installed and used in accordance with these instructions, protection against hazards may be impaired.**

### CONNECTORS

To perform wiring connections, remove the terminal block from the meter's connector, strip the wire leaving from 7 to 10 mm exposed and insert it into the proper terminal while pushing the fingertip down to open the clip inside the connector as shown in the figure.

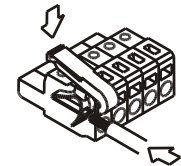

Proceed in the same manner with all pins and plug the terminal block back to the corresponding meter's connector.

Each terminal can admit wires of section between  $0.08 \text{ mm}^2$  and  $2.5 \text{ mm}^2$  (AWG 26 ÷ 14).

Some terminals have removable adaptors to provide proper fastening for wires of sections less than  $0.5 \text{ mm}^2$ .

## 3.2. PROGRAMMING INSTRUCTIONS

### To enter the programming mode

Press ENTER to make appear on display the Pro indication with LED 1 and LED 2 flashing.

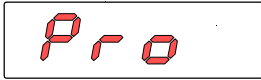

From this level, a new press on ENTER key, allows getting the different programming menus, input, display and, if the 2 RELAY option is installed, setpoints.

### To exit the programming mode

Is necessary to complete all programming steps of the chosen menu and at the end of which the instrument goes back to working mode storing all changes done.

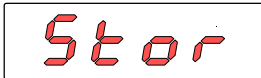

On page 12 diagram are showed all programming steps.

### Programming lockout

After completing the instrument's programming, it is recommended to lockout the access to the programming to prevent from accidental or unauthorized modifications. This operation is made by removing a jumper located on the main board circuit (see figure at right).

NOTE: Disconnect power before changing the jumper position.

While the instrument is locked out it is however possible to access to the programming routines to check the current configuration, but it won't be possible to entry or modify data. In this case, a push of **ENTER** to access the programming routines will show the indication dAtA instead of Pro

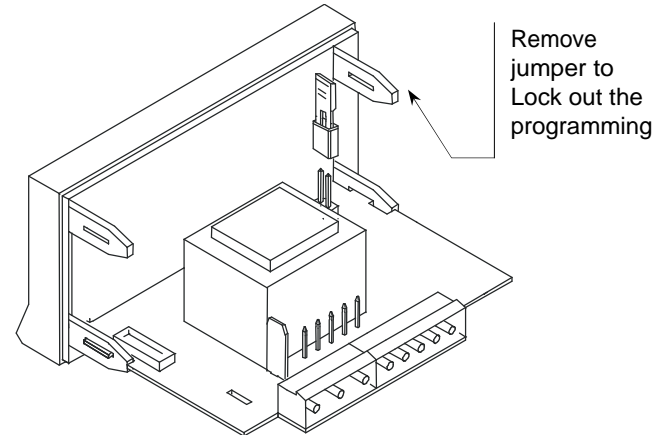

## 2.3 - PROGRAMMING DIAGRAM

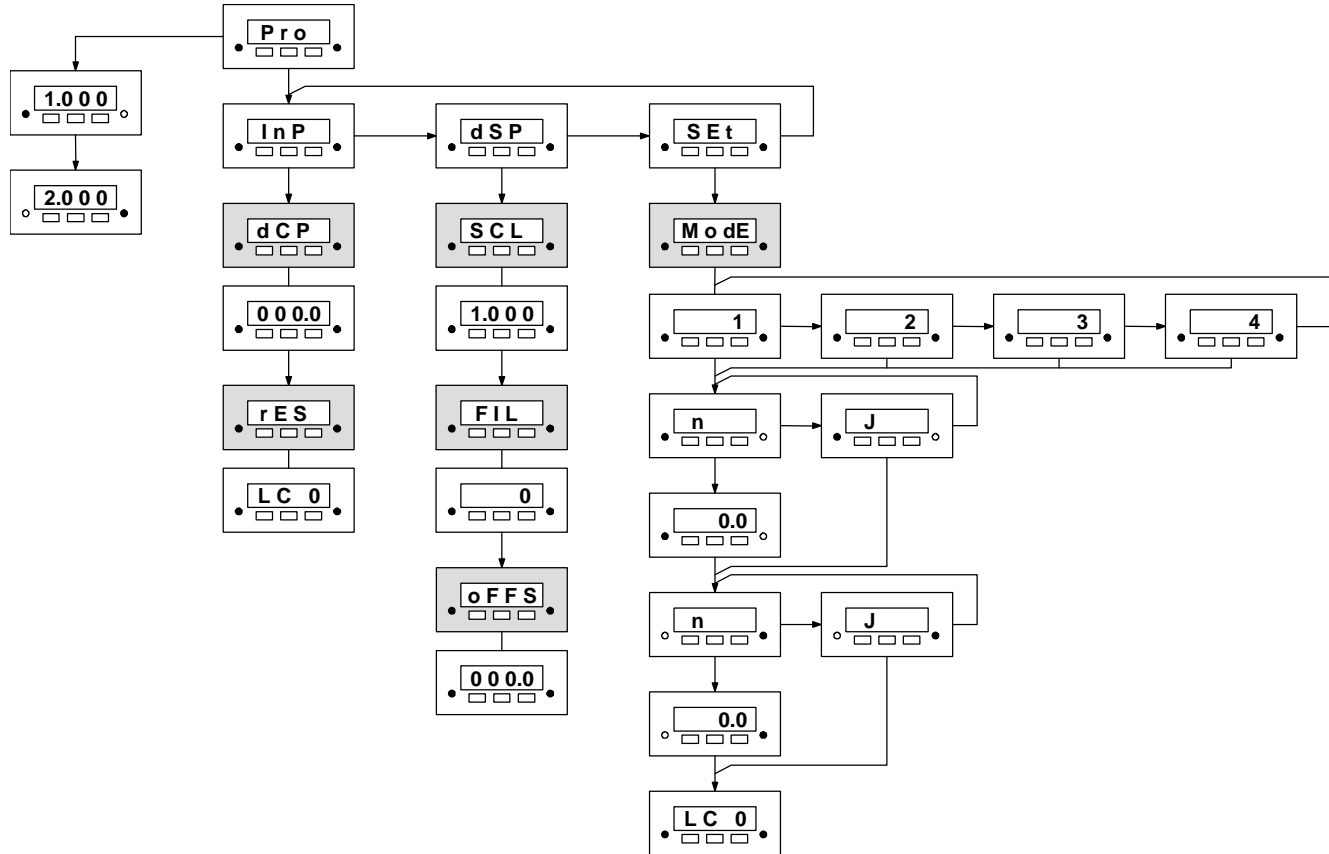

## 3.2. PROGRAMMING INSTRUCTIONS

---

On page 12 diagrams are shown all programming steps including the setpoints module that if the option is not plugged in, doesn't appear.



The left column is to program the setpoint values (only if the option is plugged in. To access it, from **Pro** press  key.

The rest of programming mode is divided in modules with independent access:

**InP**: input

**dSP**: display



**SEt**: setpoints (mode)

From **Pro** level, a press on  gives access to the programming modules. The  key allows passing from one to another cyclically. From this step, the  key will allow pass through the different menus, where we can do the following actions:



### 1. Validation and progress

To validate or select a selection or a programming and go to next level is done by  key.

### 2. Option's selection

In the menus where several options are possible these will be shown on display in a shifting way by pressing  key. To validate a selection, press  when desired option is on display.

### 3. Programming numerical values

The way of programming numerical values (as multiplying factor, setpoint values or offset value) consists on programming every digit individually, using  key to increase its value between 0 and 9, and the  key to shift to the next digit (the digit to be programmed always is blinking).

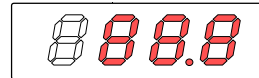

### 4. Programming decimal point

At the programming decimal point position section, this will be blinking. Pressing  key will shift from left to right the decimal point cyclically.

To have an indication without decimal point position place the decimal point

## 2.4 - INPUT CONFIGURATION

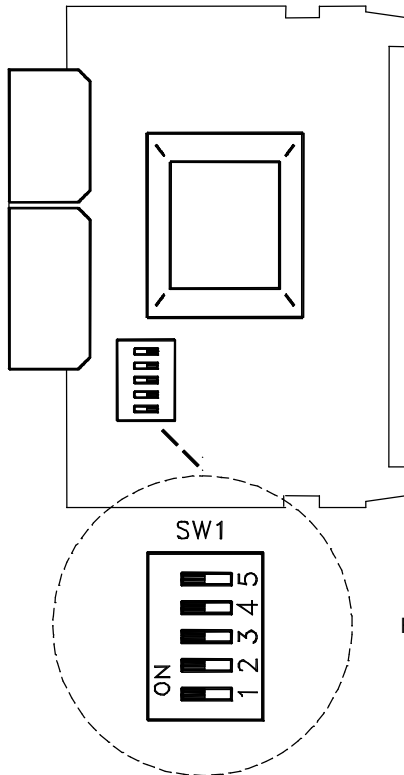

### 1. / Sensor type switch settings

Before connecting the input signal to the instrument, set the 5-position DIP-switch SW1 (see figure) according to the sensor type as indicated in the table below.

To make changes remove the instrument from the case as shown in figure 9.1.

SW1	1	2	3	4	5
Magnetic pickup	off	off	on	off	off
NAMUR sensor	on	off	on	on	off
NPN type sensor	on	on	off	off	off
PNP type sensor	on	off	off	on	off
TTL/ 24V (encoder) *	on	off	off	off	on
Contact closure	on	on	on	off	on

\* Factory set-up

Fig. 13.1. Main circuit, component side

## 2. / Signal connections.

Consult wiring advisements given in page 10.

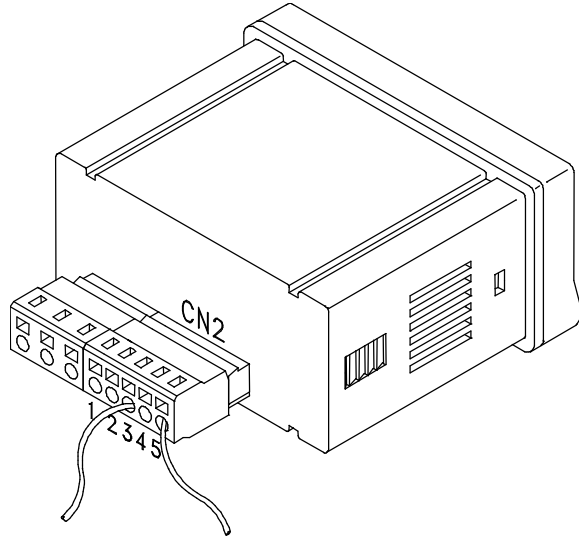

### INPUT SIGNAL CONNECTION (CN2)

PIN 1 = -IN [común (-)]

PIN 2 = +IN

PIN 3 = +EXC [24V DC (+)]

PIN 4 = +EXC [8V DC (+)]

PIN 5 = RESET

## 3. / Sensor wiring schematics.

Consult wiring advisements given in page 10.

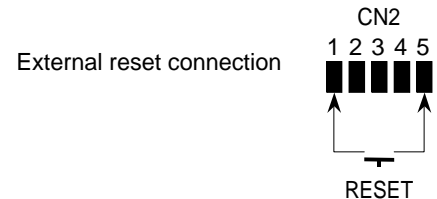
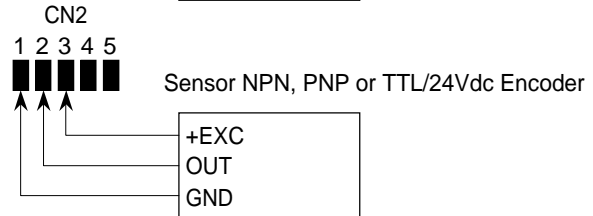
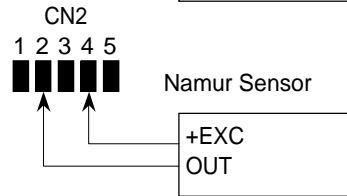
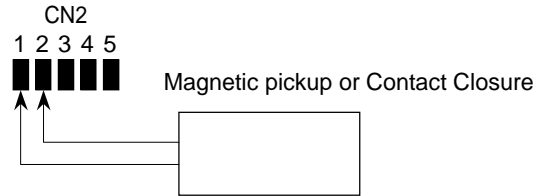

## INPUT PROGRAMMING MENU

### [16.1] Access to input menu

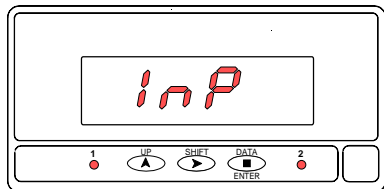

From RUN mode, press **ENTER** to access to programming mode (will be shown the indication **Pro** as in figure 13.1, Page 13, with LED's 1 and 2 blinking) Press once again **ENTER** to access to the programming menu selection. First menu is **INP** (input), press **ENTER** to enter to program input parameters.

### [16.2] Decimal point

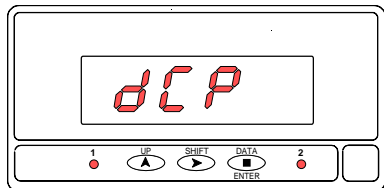

The indication **dCP** of figure 16.2 appears for a second before to allow programming decimal point position. Next appears 4 zeros with decimal point flashing. Using **▶** key shift decimal point until desired position and press **ENTER** to validate and go to next step of programming.

### [16.3] Lock out of reset key

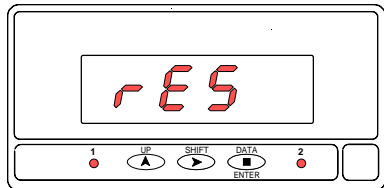

The display shows for a second the indication **rES** and later shows LC 0 ó LC 1 according the previous programmed.

Select **LC 0** to enable RESET key.

Select **LC 1** to disable RESET key. The reset function will be only possible by rear connector.

To modify this parameter, press **▶** to change the option shown on display and press **ENTER** to validate changes.

The **StorE** indication appears for a while meanwhile the changes are stored into the memory and the instrument goes back to run mode.



# DISPLAY PROGRAMMING MENU

## [17.1] Access to the display menu

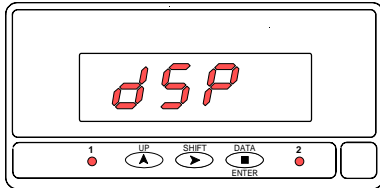

From RUN mode, press **ENTER** key to access to programming mode (will be shown the indication **Pro** figure 13.1, Page 13, with the LED's 1 y 2 blinking). Press **ENTER** key to access to the selection of programming menu. The first one is **InP** menu; press the **▶** key to SHIFT to the display menu **dSP** (see figure 17.1) and press **ENTER** to access to display configuration parameters.

## [17.2] Multiplying Factor

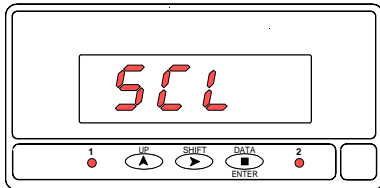

First parameter in this menu is multiplying factor, programmable from 0.001 to 9.999, going before, during a second the indication **SCL**. The previously programmed multiplying factor will appear on display with the first left digit blinking. To change the value of active digit, press repeatedly **▲** key the desired value is present and press **▶** key to SHIFT to the next digit. Repeat this operation until to get the desired value. Press **ENTER** to validate the value and go to next step. If factor is not needed program 1.000.

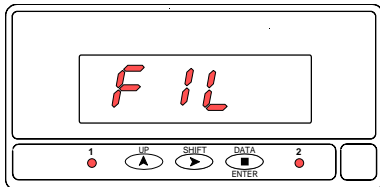

## [17.3] Filter anti debounce

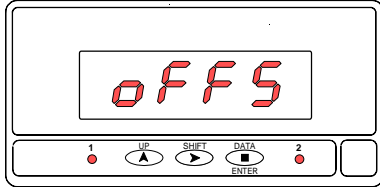

In this step is possible to activate an anti debounce filter with a cut-off frequency of 20Hz. Figure 17.3 shows the indication during 2 seconds from **ENTER** on last step. After that or pressing, "ENTER", appears on display "0" or "1" according programmed before. The zero means filter disabled and one means filter enabled. Press **▶** key if need to change the option on display and press **ENTER** to validate the selection and go to the next programming step.

## [18.1] Display offset



The indication of figure 18.1 is shown one before to pass to programming the offset value. Offset is the value that takes the counter when a reset is done. After a second appears on display the previously programmed value of offset, with the most significant digit blinking. To change the value of the active digit, press repeatedly  until the desired value is on the digit and with  key SHIFT to the right the blinking digit. Repeat this operation until have the desired value. Press  key to validate the value, store the changes and exit to RUN mode.

## 2.7. TOTALIZER. OFFSET, RESET AND MULTIPLIER FACTOR

### 2.7.1. MAIN COUNTER

The instrument counts up the number the pulses at the input, applying a factor between 0.001 and 9.999.

A factor of 0.010, means that the display value will increase 1 unit every 100 input pulses.

A factor of 2.000 will mean 2 units on display for every input pulse.

#### OFFSET

Offset is the value that appears on display when is made a reset.

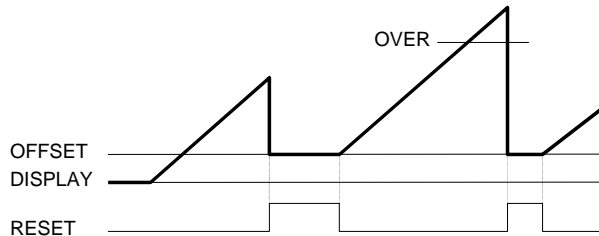

#### RESET OF MAIN COUNTER

The reset of counter can be made or by the front key (UP) or by short-circuiting pin 5 (RESET) and pin 1 (COMMON) on the rear connector.

Applying a reset, the counter is put to zero or to offset value and is hold as long as the signal is active.

### 2.7.2. TOTALIZER

The totalizer option is always active and is not possible to disable it. Consists in a 6-digit counter that increases at every input pulse applying the programmed factor. The reset of totalizer is independent of main counter and always is reset to zero since has no offset possibility.

#### VISUALIZATION OF TOTALIZER

The visualization of total is done in two sequences of three digits every one. The three less significant digits with the letter 'L' and the three most significant digits with the letter 'H'. Pressing the SHIFT key, begin the sequence of visualization, which remains during 10 seconds, alternating high and low value every second. Decimal point is in the same position as main counter. With other pushing on SHIFT key return to the normal display.

A digital display showing the high digits of the totalizer: 'H 123'. The 'H' is on the left, followed by the digits '1', '2', and '3'.

A digital display showing the low digits of the totalizer: 'L 45.6'. The 'L' is on the left, followed by the digits '4', '5', and '6' with a decimal point after the '5'.

#### RESET OF TOTALIZER

To reset the totalizer, press simultaneously TARE y SHIFT keys for 3 seconds, after that begin the total visualization sequence, with its value reset to zero.

## 3. SETPOINT OUTPUT OPTION

### 3.1. BOARD CONNECTION

As an option, the Jr/Jr20-IMP models can be equipped with the following output option:

- A control output card with two SPDT relays outputs rating 8 A @ 250 V AC / 150 V DC. The outputs can be programmed for HI or LO operation and selectable time delay or hysteresis action.

#### **Ref. 2RE**

The 2RE option consists of an additional card installable to the meter's main board by means of a plug-in connector.

The option is supplied with a specific instructions manual describing installation and characteristics. Nevertheless, the programming instructions are given in the Jr/Jr20-IMP manual.

For more detailed information on characteristics, applications and mounting please refer to the specific 2RE instructions manual.

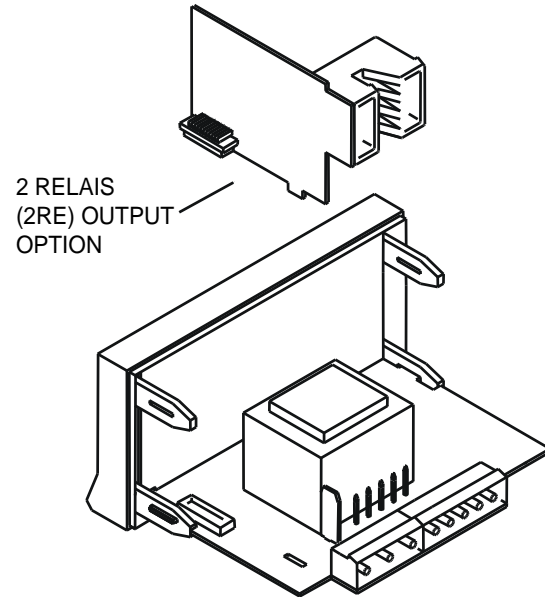

## 3.2. SETPOINTS OPERATION'S MODE

---

The setpoints are programmed with four digits and only can be referred to the main counter, not to the totalizer.

The setpoints-programming module allows selecting the operating mode of relays output:

**Impulsional**, means that the relay is activated at its setpoint value and deactivated automatically after the selected time. This allows programming the activation time between 0.1 s and 9.9 s

**Hold**, means that the relay is activated at its setpoint value and hold this state until a reset put the display down of setpoint value.

Likewise is possible to choose one of four operating modes described on right paragraph:

**Mode 1:** The relays are activated when the counter reaches its respective setpoint values. If the outputs are impulsional types, will be deactivated at the end of programmed time. If are type hold, will remain active until a reset put the main counter to a value down of setpoint values.

**Mode 2:** Relay 1 activates when the counter reaches the setpoint value. The relay 2 stops the counter when it reaches the setpoint value and remains stopped until a reset is done.

**Mode 3:** The relay 1 is activated at setpoint 1 value. When the counter reaches the setpoint 2 value, resets the counter. If the output of relay 2 is impulsional, will be active only the programmed time. The relay 1 will be deactivated if the offset value is lower than the setpoint 1.

**Mode 4:** The relay 1 is activated at its setpoint value. When the counter reaches the setpoint 2 value, the relay 2 is activated and relay 1 if it were activated, will be deactivated. The relay 2 remains activated and the counting follows until a reset puts the counter to zero or offset value.

### 3.3. OPERATION'S MODE DIAGRAMS

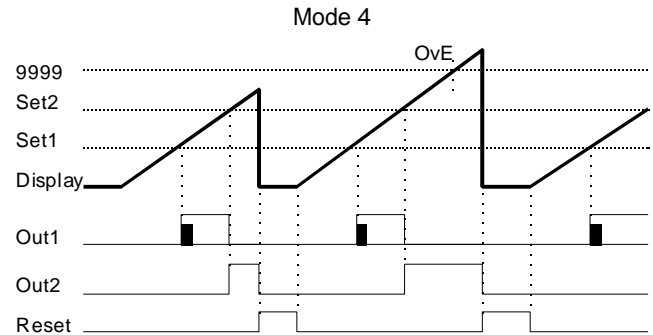
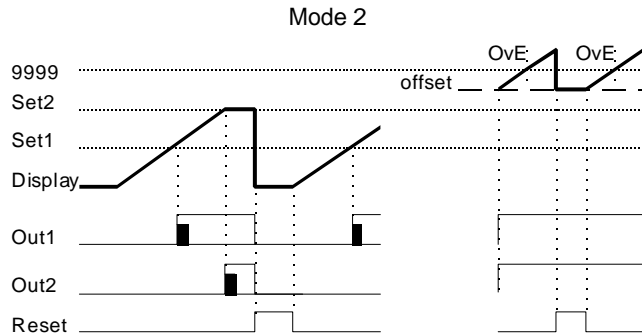
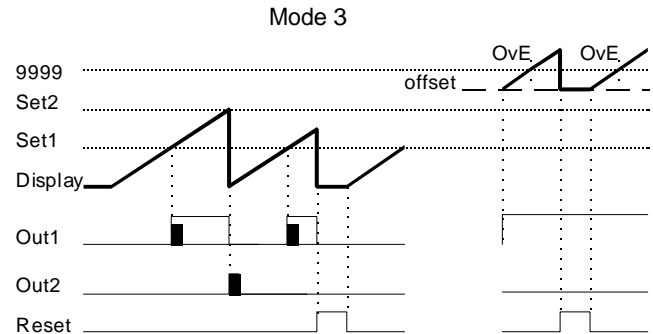
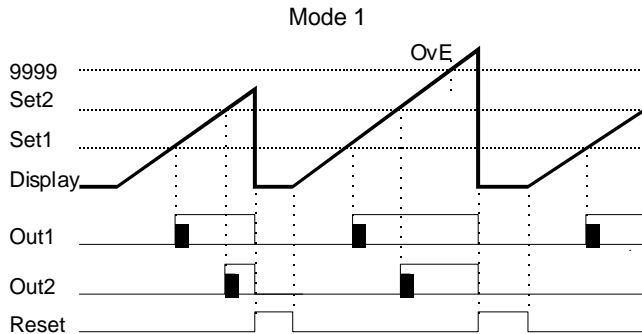

On diagrams are showed the actuation of setpoints (Out 1 y Out 2) in mode impulsional (  ) and in hold mode (  )

## 3.4. SETPOINT VALUE PROGRAMMING

### [23.1] Setpoints Programming

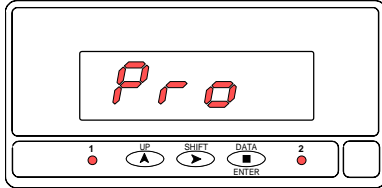

To program the setpoint values, press **ENTER** to access the programming mode (indication **Pro**, figure 25.1) and press **▲** to make the display show the previously programmed value of setpoint 1.

NOTE: The setpoint values should be programmed within the selected measurement range.

### [23.2] Setpoint 1 value

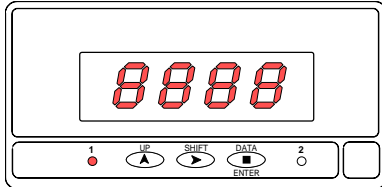

Program setpoint 1 value, LED 1 activated.

The initially programmed value appears on the display with the first digit flashing. Press repeatedly the **▲** key to increment the active digit from 0 to 9 until it takes the desired value and press **▶** to advance to the next digit to be modified. Repeat these operations to complete the desired setpoint value with sign.

Press **ENTER** to validate the entry and pass to the programming of setpoint 2.

### [23.3] Setpoint 2 value

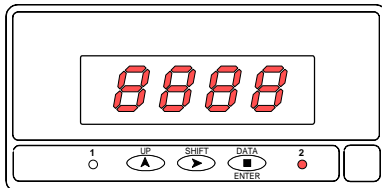

Program setpoint 2 value, LED 2 activated.

Program the setpoint 2 value with sign by means of the **▲** (change value) and **▶** (change digit) procedure as described in previous phase.

Press **ENTER** to store programmed data in the memory and exit from the programming mode.

## SETPOINTS MENU PROGRAMMING

### [24.1] Access to the menu

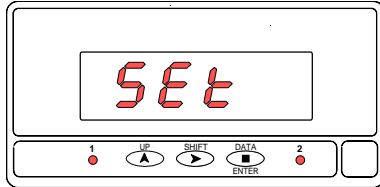

From the RUN mode, press **ENTER** to access to the programming mode (the indication **Pro** will be shown, (see figure 13.1, Page 13), with LED 1 and LED 2 blinking. Press **ENTER** once again, to access to the programming selection menu. First menu is **InP**. press twice the **▶** key to shift to programming setpoints **SEt** (see figure 24.1) and press **ENTER** to access to the operating mode configuration.

### [24.2] Operation's mode

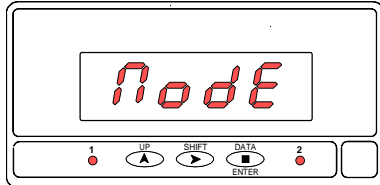

The indication of figure 24.2 will be shown for 2 second before to enter in control mode programming. After 2s or pressing **ENTER** key appears on display a blinking number between 1 and 4.

This number corresponds to the previously selected mode. Press as times, as needed the **▶** key to change the mode number and, with desired value (see Pages. 21 and 22), press **ENTER** to store and go to the next sep.



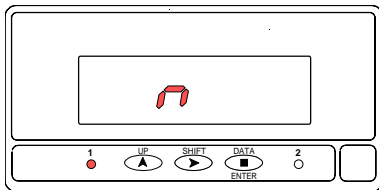

## [25.1] Activation mode

Impulsional output



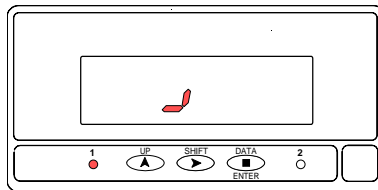



Hold output

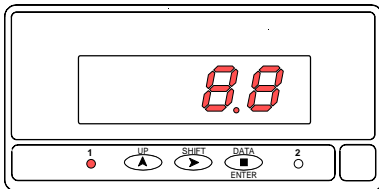

The display shows one of the indications of figure 25.1, where first corresponds to the impulsional mode and the second one to the hold mode according to the explanation on Page 21. The LED 1 activated means that we are programming the setpoint 1. Press  if it is needed to change the actual option and press  to validate and pass to next step.



## [25.2] Pulse time

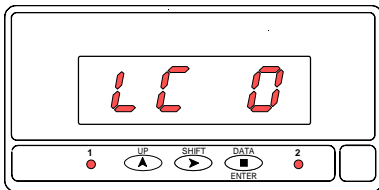

If the previous step has been selected as a hold (Fig. 25.1) pressing  goes to program the setpoint 2 (will activate LED 2)  
If has been selected impulsional mode, the next step allows programming the time of duration of output pulse (Figure 25.2). Use  and  key to program the desired value between 0,1 and 9,9 seconds.  
Press  to validate the selected value and repeat steps 25.1 and 25.2 to configure the activation mode for setpoint 2 (LED 2 activated)

## [25.3] Lock of module SET



After programming the previous steps we have to decide if lock or not the setpoints parameters.  
Press  to see the options:  
Select **LC 0** to have absolutely opened the programming of setpoints menu. Select **LC 1** to lock the possibility of modifying setpoints parameters **SET menu** (only will be possible to change the setpoint values).  
Press  to store into memory, and return to mode RUN.

## 4. TECHNICAL SPECIFICATIONS

### INPUT SIGNAL

- Max. Frequency..... 4 KHz
- Excitation..... 8 V @ 20 mA or 22 V  $\pm$ 5 @ 20 mA

#### Magnetic pickup

- Sensitivity.....  $V_{in}$  (AC) > 120 mV eff.

#### NAMUR sensor

- $R_c$ ..... 1 K $\Omega$  (incorporated)
- $I_{on}$ ..... < 1 mA DC
- $I_{off}$ ..... > 3 mA DC

#### NPN and PNP type sensors

- $R_c$ ..... 1 K $\Omega$  (incorporated)
- Logic levels..... "0" < 2.4 V DC, "1" > 2.6 V DC

#### TTL/24V DC (encoder)

- Logic levels..... "0" < 2.4 V DC, "1" > 2.6 V DC

#### Contact closure

- $V_c$ ..... 5 V
- $R_c$ ..... 3.9 K $\Omega$  (incorporated)
- $F_c$ ..... 20 Hz

### POWER SUPPLY

- AC..... 230/115 V, 24/48 V ( $\pm$ 10%) 50/60 Hz AC
- DC 12 V (10.5 to 16 V), 24 V (21 to 32 V), 48 V (42 to 64 V)
- Consumption..... 3 W

### FUSES (DIN 41661) - (Recommended)

- JR/ JR20-IMP (230/115V AC) ..... F 0.1A / 250 V
- JR/ JR20-IMP2 (24/48V AC) ..... F 0,2A / 250 V
- JR/ JR20-IMP3 (12 V DC)..... F 1A / 250 V
- JR/ JR20-IMP4 (24 V DC)..... F 0.5A / 250 V
- JR/ JR20-IMP5 (48 V DC)..... F 0.5A / 250 V

### DISPLAY

- Type..... 9999, 7-segment red LED
- JR-IMP ..... 4 digits, 14 mm high
- JR20-IMP ..... 4 digits, 20 mm high
- Decimal point ..... programmable
- LED's..... 2 setpoint status
- Over-range indication ..... OvE

### ENVIRONMENTAL

- Indoor use
- Operating temp..... -10 °C to 60 °C (0 °C to 50 °C acc. to UL)
- Storage temperature ..... -25 °C to +85 °C
- Relative humidity (non condensing)..... <95 % to 40 °C
- Max. Altitude..... 2000 m

### DIMENSIONS

- Dimensions ..... 96 x 48 x 60 mm
- Panel Cut-out ..... 92 x 45 mm
- Weight ..... 250 g
- Case material ..... polycarbonate s/UL 94 V-0

## 4.1 - Dimensions and mounting

To install the instrument into the panel, make a 92x45 mm cut-out and insert the instrument from the front placing the sealing gasket between this and the front bezel.

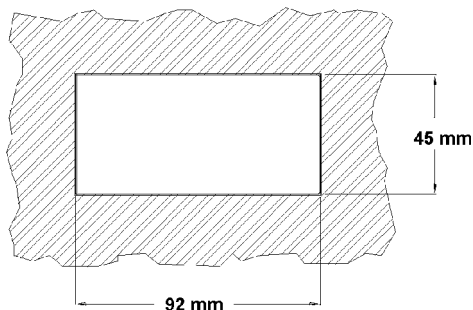

Place the fixing clips on both sides of the case and slide them over the guide tracks until they touch the panel at the rear side. Press slightly to fasten the bezel to the panel and secure the clips.

To remove the instrument from the panel, pull outwards the fixing clips rear tabs to disengage and slide them back over the case.

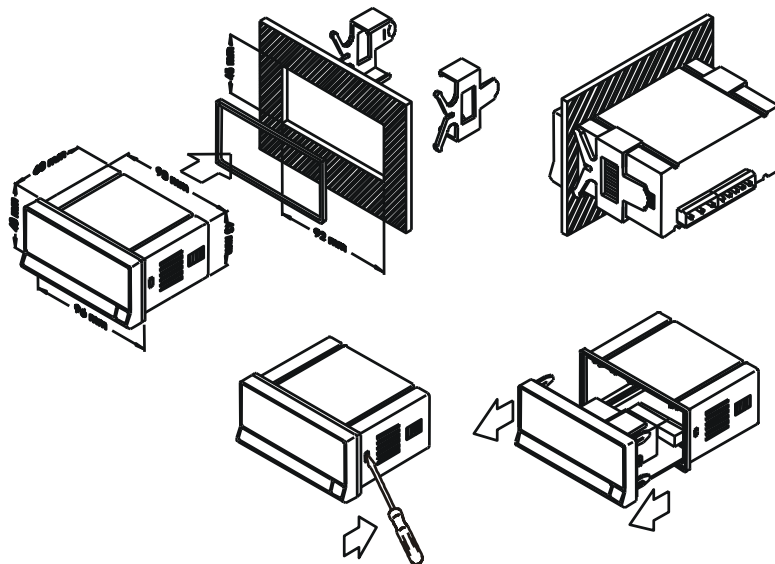

**CLEANING:** The front cover should be cleaned only with a soft cloth soaked in neutral soap product. **DO NOT USE SOLVENTS**



The instruments are warranted against defective materials and workmanship for a period of three years from date of delivery.

If a product appears to have a defect or fails during the normal use within the warranty period, please contact the distributor from which you purchased the product.

This warranty does not apply to defects resulting from action of the buyer such as mishandling or improper interfacing.

The liability under this warranty shall extend only to the repair of the instrument. No responsibility is assumed by the manufacturer for any damage which may result from its use.



All the DITEL products benefit from an unlimited and unconditional warranty of THREE (3) years from the date of their purchase. Now you can extend this period of warranty up to FIVE (5) years from the product commissioning, only by fulfilling a form.

Fill out the form in our website:

**<http://www.ditel.es/warranty>**



## 6. DECLARATION OF CONFORMITY

Manufacturer: DITEL - Diseños y Tecnología S.A.

Address : Travessera de les Corts, 180  
08028 Barcelona  
ESPAÑA

Declares, that the product:

Name: Digital panel meter

Model: JR-IMP and JR20-IMP

Conforms with: EMC 89/336/CEE  
LVD 73/23/CEE

Date: 1 February 2002

Signed: José M. Edo

Charge: Technical Manager



Applicable Standards : **EN50081-1** Generic emission  
EN55022/CISPR22 Class B

Applicable Standards: **EN50082-1** Generic immunity  
IEC1000-4-2 Level 3 Criteria B  
Air Discharge 8 kV  
Contact Discharge 6 kV

IEC1000-4-3 Level 2 Criteria A  
3V/m 80..1000MHz

IEC1000-4-4 Level 2 Criteria B  
1 kV Power Lines  
0.5 kV Signal Lines

Applicable Standards: **EN61010-1** Generic Safety  
IEC1010-1 Installation Category II  
Transient Voltages <2.5 kV  
Degree of Pollution 2  
Conductive pollution excluded  
Insulation type  
Enclosure: Double  
Inputs/Outputs: Basic





## INSTRUCTIONS FOR THE RECYCLING

This electronic instrument is covered by the **2002/96/CE** European Directive so, it is properly marked with the crossed-out wheeled bin symbol that makes reference to the selective collection for electrical and electronic equipment which indicates that at the end of its lifetime, the final user cannot dispose of it as unsorted municipal waste.

In order to protect the environment and in agreement with the European legislation regarding waste of electrical and electronic equipments from products put on the market after 13 August 2005, the user can give it back, without any cost, to the place where it was acquired to proceed to its controlled treatment and recycling.

### **DISEÑOS Y TECNOLOGIA, S.A.**

Polígono Industrial Les Guixeres

C/ Xarol 8 C

08915 BADALONA-SPAIN

Tel : +34 - 93 339 47 58

Fax : +34 - 93 490 31 45

E-mail : [dtl@ditel.es](mailto:dtl@ditel.es)

[www.ditel.es](http://www.ditel.es)