

## KOS1605P USER GUIDE

SMART DIN RAIL MOUNTED TRANSMITTER INPUT PT100  
 TWO WIRE (4 to 20) mA



According to 2012/19/EU Directive, You cannot dispose of it at the end of its lifetime as unsorted municipal waste. You can give it back, without any cost, to the place where it was acquired to proceed to its controlled treatment and recycling.



**Important - Please read this document before any installing.**

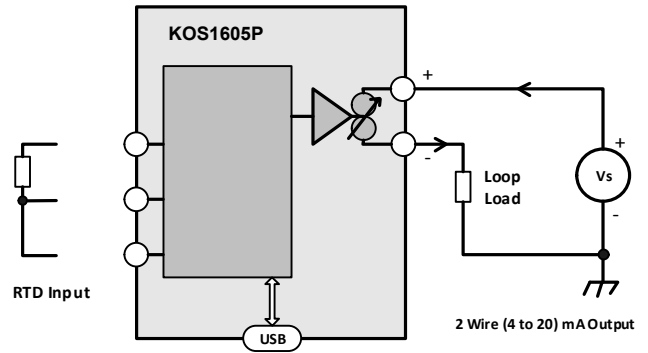

Every effort has been taken to ensure the accuracy of this document, however we do not accept responsibility for damage, injury, loss or expense resulting from errors and omissions, and we reserve the right of amendment without notice.



### IMPORTANT - CE & SAFETY REQUIREMENTS

Product must be mounted inside a suitable enclosure providing environmental protection to IP65 or greater.

To maintain CE EMC requirements, input wires must be less than 30 metres.

The product contains no serviceable parts, or internal adjustments. No attempt must be made to repair this product. Faulty units must be returned to supplier for repair.

This product must be installed by a qualified person. All electrical wiring must be carried out in accordance with the appropriate regulations for the place of installation.

Before attempting any electrical connection work, please ensure all supplies are switched off.

ABSOLUTE MAXIMUM CONDITIONS ( To exceed may cause damage to the unit ) :-

Supply Voltage	± 30 V dc (Protected for over voltage and reverse connection)
Current with over voltage	± 100 mA
Input Voltage	± 3 V between any terminals
Ambient	Temperature (-30 to 70) °C Humidity (10 to 95) % RH (Non condensing)

## PRODUCT SPECIFICATION

Please refer to the product data sheet for full specification, available to download at [www.ditel.es](http://www.ditel.es)

## RECEIVE AND UNPACKING

Please inspect the packaging and instrument thoroughly for any signs of transit damage. If the instrument has been damaged, please notify your supplier immediately.

## CONFIGURATION



**IMPORTANT - The KOS1605P can be configured whilst connected and powered, but a portable battery powered computer must be used to avoid the effects of ground loops.**

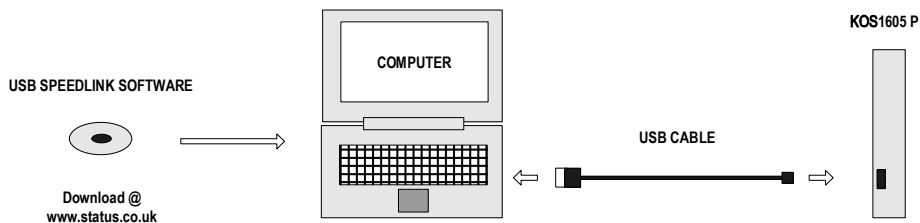

The following parameter can be configured by simply entering as prompted by the software package.

- RTD INPUT TYPE ( Pt100, Ni100, Ni120, CU53, CU100 )**
- Low range
  - High range
  - Units °C, °F
  - Burnout (direction of output current on sensor burnout)

**Factory default:**

RTD	= Pt100
IEC	= 003851
Low Range	= 0
High Range	= 100
Units	= °C
Burnout	= UPSCALE

## MECHANICAL INSTALLATION

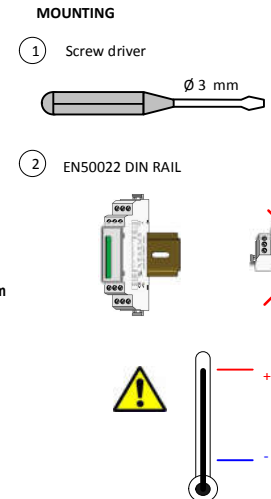
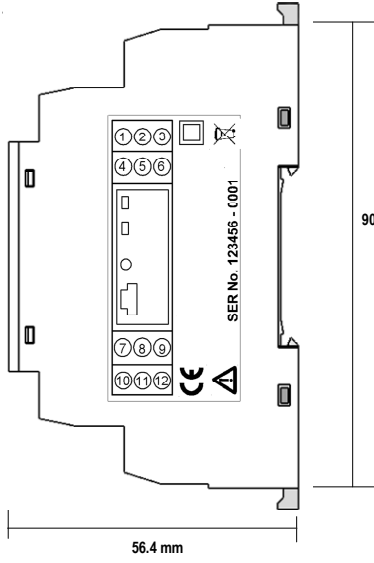

**SEM1605P Enclosure**

Style	DIN 43880 (1 module width)
Material	Polyamide 6.6 self extinguishing
Terminals	Screw terminal
Cable	2.5 mm Max
Colour	Grey

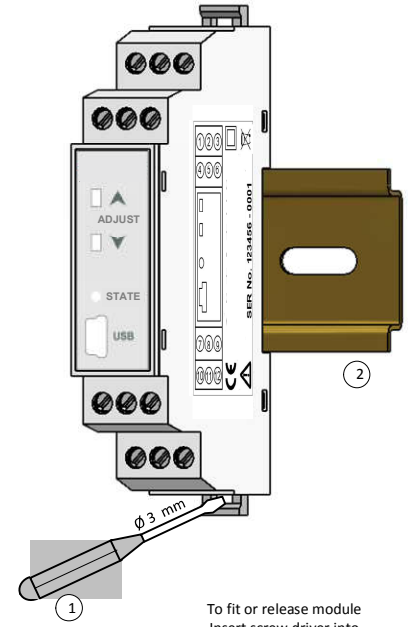

To fit or release module  
Insert screw driver into  
slot and lever latch  
away from body

## ELECTRICAL INSTALLATION

Screened Cable



Twisted Pair Cable



Screw Driver



TURN OFF SUPPLY BEFORE WORKING ON ANY ELECTRICAL CONNECTION

### INPUT CONNECTION

RTD wire must be equal length and type .  
To maintain CE compliance cable length must be less than 30 metres.

### OUTPUT CONNECTION

Use twisted pair or screened cables for cable lengths greater than 30 metres. Max cable length 1000 metres. Ensure loop is grounded at one point.

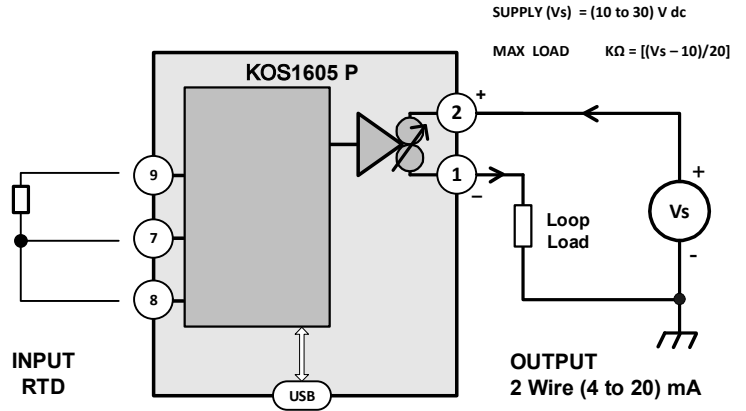

**Button Configuration options.**

The KOS1605P has three options selectable in the USB Speed Link software, Trim, Range and off

**USER ADJUST**

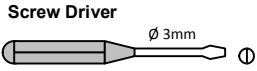

Power supply (10 to 30) Vdc

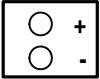

Resistor Decade box

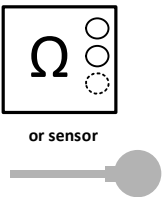

User adjust function allows manual adjustment of the output current, this is useful for minor calibration adjustment or trimming out any sensor error,  $\pm 5\%$  of range adjustment is available at both offset and span. Raise and lower buttons are provided on the front panel of the transmitter, accessed using a 3 mm flat blade screw driver. Insert the screw driver into the appropriate slot to operate the button. The button has a click action.

The transmitter will automatically detect the correct adjust point (offset or span) based on the output current drive. Offset will be adjusted when the current is between (3.8 to 6) mA, span when the current is between (18 to 22) mA. No trim action occurs at any other current.

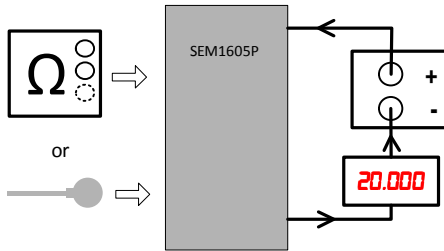
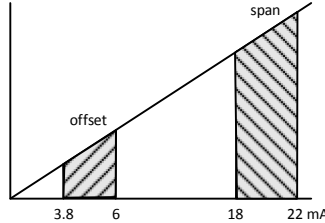

**METHOD**

1.0 In USBSpeedLink software set the "Buttons" drop box to trim (this is the default setting).

Connect transmitter to a suitable Resistor decade box or sensor. Connect output to a dc supply, connecting a digital mA current meter in series with the output. Turn supply on, set input to either offset or span calibration point.

2.0 Press and hold the red up arrow for 10 s until the STATE LED starts to flash, then release the button

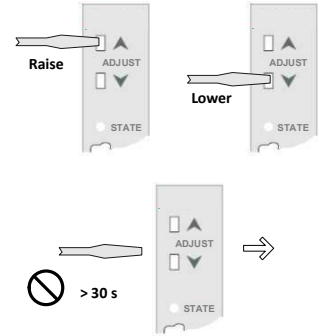

23.0 Adjust output current by pressing either the raise or lower button, single click to step advance, or press continuously to auto advance.

34.0 Once adjust is complete allow 30 seconds with no button press, the transmitter will time out and return to normal operation.

**USER RANGE**

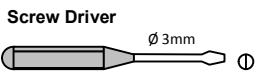

Power supply (10 to 30) Vdc

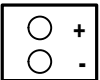

Resistor Decade box

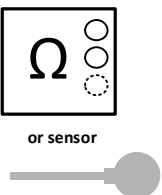

User range function allows manual adjustment of the 4 mA and 20 mA output range in relation to the input value.

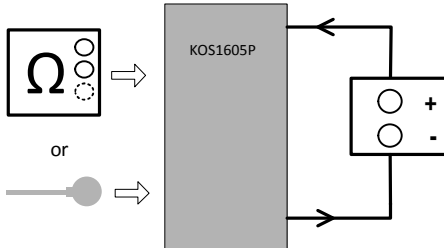

Method In USBSpeedLink software set the "Buttons" drop box to active range (this is not the default setting).

1.0 Connect the resistor decade box or the input sensor to the SEM1605P using the three connection terminals. Connect the SEM1605P to a (10 to 30) VDC power supply, a digital ammeter connected in series with the KOS1605P will be useful to monitor the (4 to 20) mA current but is not essential. Turn on the supply and allow 1 minute warm up period.

2.0 Set the resistance decade box to the equivalent resistance of the sensor for the required low range temperature, or apply required low range temperature to the sensor. Allow 10 seconds for the KOS1605P to settle.

3.0 Press and hold the Low range ADJUST button, marked with a blue down arrow, until the STATE LED starts to flash, then release the button. Press and release the Low range ADJUST button again, the STATE LED will flash quickly for a short time and the new low range will be stored. The output current will go to 4.0 mA.

4.0 Set the resistance decade box to the equivalent resistance of the sensor for the required high range temperature, or apply required high range temperature to the sensor. Allow 10 seconds for the SEM1605P to settle.

5.0 Press and hold the High range ADJUST button, marked with a Red up arrow, until the STATE LED starts to flash, then release the button. Press and release the High range ADJUST button again, the STATE LED will flash quickly for a short time and the new high range will be stored. The output current will go to 20.0 mA. The ranging of the KOS1605P is now complete.

**OFF**

Pressing the button has no action.

Note:- The Low and High user adjust can be set individually and in any order as required.